



INDUSTRIAL GAS APPARATUS

Regulators & Flow Control Equipment • Welding Accessories • Pressure Gauges

Technology for a Better Future



TABLE OF CONTENTS

GENTEC® Gas Welding & Cutting Apparatus

Industrial Gas Apparatus

01.-06. Gold Series Deluxe Outfits



- 02. JOBBER & JOBBER II
- 03. IRON HORSE & IRON HORSE II
- 04. COMMANDER & COMMANDER II
- 05. EXCALIBUR
- 05. THE BOSS
- 06. TOTE-A-TORCH

07. Cutting Outfits



08.-09. Torch Handles



- 08. 140, 141, 142, 143 Series
- 09. 342, 442, 443 Series

10-11 Cutting Attachments



12.-13. Hand Cutting Torches



14. Machine Cutting Torches & Accessories



- 15.
- 15.
- 16.



- 17. Welding Nozzles
- 18. Welding Nozzles-Multiple Gas
- 19. Special Brazing Nozzles



20.-21. Heating Nozzles



22.-23. Cutting Tips



24.-26. The Small Torch



- 25. The Small Torch Outfits
- 26. Components & Accessories

27.-30. The Compact Torch



- 28. The Compact Torch Outfits
- 29.-30. Components & Accessories

31. MUL-T-TORCH Outfit & Components



**32.-70. Compressed Gas Regulators
Single Stage Regulators**



- 33. 591 High Pressure Piston Regulator
- 34. 190 Single Stage Regulator, Light Duty
- 35. 210 Single Stage Regulator, Light Duty



- 36. 152 Single Stage Regulator, Medium Duty
- 37. 452 Single Stage Regulator, Medium-Heavy Duty
- 38. 453 Single Stage Regulator, Medium-Heavy Duty
- 39. 853 Single Stage Regulator, Medium-Heavy Duty



- 40. 853LCR Single Stage Regulator, Liquid Cylinder
- 41. 153 Single Stage Regulator, Heavy Duty
- 42. 155 Single Stage Regulator, Extra Heavy Duty
- 43. 155HF Single Stage Regulator, High Pressure, High Flow
- 44. 156D Combination Spring and Dome Loaded Regulator

Two Stage Regulators



- 45. 152T Two Stage Regulator, Medium Duty
- 46. 153T Two Stage Regulator, Heavy Duty
- 47. 155T Two Stage Regulator, Extra Heavy Duty
- 48. 462TF Two Stage Regulator, High Pressure

Station Regulators



- 49. 152S Station Regulator, Medium Duty
- 50. 853S Station Regulator, Medium-Heavy Duty
- 51. 853SR Station Regulator, Rear Entry
- 52. 155S Station Regulator, Heavy Duty

Pipeline Regulators



- 53. 152L Pipeline Regulator, Medium
- 54. 853L Pipeline Regulator, Medium-Heavy Duty
- 55. 155L Pipeline Regulator, Heavy Duty

Manifold Regulators



- 56. 153M Manifold, Single Stage Regulator, Heavy Duty
- 57. 153TM Manifold, Two Stage Regulator, Heavy Duty
- 58. 155M Manifold, Single Stage Regulator, Extra Heavy Duty
- 59. 155TM Manifold, Two Stage Regulator, Extra Heavy Duty

Flowgauge Regulators



- 60. 190AR1 Flowgauge Regulator, Light Duty
- 60. 190AR Flowgauge Regulator, Light Duty
- 61. 152 Flowgauge Regulator, Medium Duty

Compact Pre-Set Flow Regulators



- 62. 220, 227, 229 Series

Flowmeter Regulators



- 63. 191 Flowmeter Regulator, Single Stage, Medium Duty
- 63. 791AR Flowmeter Regulator, Single Stage, Light Duty
- 64. 195 Flowmeter Regulator, Single Stage, Heavy Duty
- 64. 195T Flowmeter Regulator, Two Stage, Heavy Duty
- 66. 196 Dual Flowmeter Regulator, Single Stage, Medium Duty

TABLE OF CONTENTS

GENTEC® Gas Welding & Cutting Apparatus

Industrial Gas Apparatus

65. MIG/TIG Shielding Gas Kits



66. Flowmeters, 195FM



67. CO2 Flowmeter Regulators



- 67. 198CD-60 Electrically Heated Flowmeter Regulator for CO₂
- 67. 199CD-60 Radiator Flowmeter Regulator for CO₂

68.-69. Gas Saving Flowmeter Regulators



- 68. 195AE-60 Gas Saving Flowmeter Regulator
- 69. 194CE Gas Saving Electrically Heated Flowmeter Regulator
- 69. 195FE Gas Saving Flowmeter Regulator

70.-72. Balloon Filler Regulators & Accessories

- 70. 229, 230 & 230HB
- 71. 230H & 230HGMYA for Mylar & Latex Balloon
- 72. Accessories

73. Nitrogen Tire Inflation Kits & Components



74.-78. Regulator Accessories



- 74. Pressure Gauges
- 75. Gauge Protectors
- 76. CGA Inlets, Nuts & Nipples
- 77. CGA Adaptors
- 78. Outlet Bushings
- 78. Check Valves
- 78. Locking Adjusting Screws
- 78. Shut-Off Valves
- 78. Tee Couplers
- 78. Inert Arc Fittings
- 78. Y Connections / Valves

79. Hose Accessories



- 79. Hose Repair Kits & Crimping Tools
- 80. Hose Fittings (Nuts & Nipples)
- 80. Hose Couplers, Splicers & Adapters
- 80. Hose Ferrules & Braces

81. Welding Accessories



- 81. Tips Cleaners
- 81. Cylinder Wrenches
- 81. Strikers
- 81. Welding Hoses
- 81. Welding Goggles

82.-87. Technical Data

Welding, Heating & Brazing Tips
Cutting Tips, 172 & 173
Cutting Tips, 472, 473, 672 & 673
Cutting Tips, 672 & 572
Cutting Tips, 573 & 772

88.-96. Index & Comparison Charts

97.-99. Cross Reference Charts

100. Related Catalogs

THE BEST WARRANTY IN THE BUSINESS
2 Year “Over the Counter Replacement” Warranty

Any GENTEC® apparatus found to be defective either in material or workmanship during the time set forth below will be replaced by Genstar Technologies Company, Inc. or its Authorized Distributors, provided that said apparatus was used under normal conditions for the purpose intended.

Any GENTEC® apparatus damaged or rendered inoperative due to abuse, negligence, misuse, accident or abnormal wear and tear is not covered by this warranty and must be repaired at the sole expense of the equipment owner. GENTEC® apparatus should be serviced facilities only. Service or repair of this apparatus by other than Genstar Technologies Company, Inc. or designated service facilities may void any warranties and relieve Genstar Technologies Company, Incorporated of any claims for damage and/or liability.

To make a claim under this warranty, Buyer must notify Genstar Technologies Company, Inc. or its Authorized

Distributor of the details of such claim within 30 days of discovering a defect in material or workmanship along with proof of purchase. The Buyer will be responsible for transportation costs and related risks.

Genstar Technologies Company, Inc. shall not, under any circumstances, be liable for any damages including but not limited to: indirect, incidental, consequential, or special damages, wether such damages result from negligence, breach of warranty or otherwise.

There are no other warranties, expressed or implied, except as stated herein. This warranty gives you specific legal rights, and you may also have other rights which vary from state to state. Genstar Technologies company, Incorporated reserves the right to discontinue manufacturing of any product or change product materials, design or specifications without notice.

* GENTEC® Industrial Manifold Systems are not included in this catalog.



Company Overview

Genstar Technologies Company, Inc. (**GENTEC®**), founded in 1969, is a global industry leader in the manufacturing of welding apparatus, pressure regulators, and gas control systems.

Additionally, as a total system solution provider, **GENTEC®** offers technical support, on-site evaluation, and design/ implementation.

GENTEC® engineers examine all customer requirements in order to develop and recommend the best customer specific solutions.

The company takes great pride in fostering a strong relationship with each and every customer. Today, **GENTEC®** sells its products through a vast distribution network which extends to thousands of customers worldwide.

Quality Assurance

All of our products are manufactured under stringent quality control. We are ISO 9001:2001, ISO13485, and API certified. Our products meet UL, CE, SEMI, and various international standards and certifications.

Manufacturing Capabilities

The manufacturing facility is equipped with CNC machining centers, electropolishing equipment, and precision automatic orbital welding systems, among other features, to ensure the production of the highest quality products.

Our class 10/100/1000 clean rooms are designed for Ultra High Purity (UHP) products. UHP products undergo precision machining, surface finishing, electro-polishing and passivation. All UHP products are cleaned by 18MΩ DI water in a cascade ultrasonic tank. To ensure the highest UHP product quality, they are then vacuum-dried and double-bagged.

Gold Series Outfits

GENTEC® Gold Series packaged welding, cutting, brazing, and heating outfits are designed for efficient, oxy-fuel gas manual operations. All components are manufactured under stringent quality controls and carefully selected to provide optimum performance and service life. Most of the components, where applicable, are listed with Underwriters Laboratories, Inc.

With a wide variety of outfit selections, you will find the outfit you need: from light duty hobby jobs to medium duty maintenance applications to heavy duty scrapping operations.

PRODUCT CATEGORY

- 1120 JOBBER
- 1121 JOBBER II
- 1138 IRON HORSE
- 1130 COMMANDER
- 1131 COMMANDER II
- 12-PTC TOTE-A-TORCH
- 4121 EXCALIBUR
- 4130 THE BOSS DELUXE
- 4131 THE BOSS



JOBBER 1120 & 1120FA

Medium Duty Outfits in Deluxe Tool Bag for General Purposes

- Can weld up to 1/4" and cut up to 1/2"
- Ideal for home, farm, construction, and industrial maintenance facilities
- With optional tips, can weld up to 1 1/4" and cut up to 6"
- Regulators come with Steel Gauge Guards
- 20' T-grade twin hoses
- 1120 is equipped with 24-CV7PR Torch End Check Valves
- 1120FA is equipped with FA7TPR Flashback Arrestors, which include built-in check valves



1120

Model Number	Dimension/Weight	Torch Handle	Cutting Attachment	Regulators	Cutting Tip	Heating Nozzle	Welding Nozzles	T-Grade Twin Hoses	Goggles	Striker	Tip Cleaner	Check Valves
												Flashback Arrestors
1120	21"x19"x9" 20.6 lbs.	142T	142C	152X-80G (OXY.) 152Y-15G (ACET.)	172C-0	172H-6	172W-0,2,4	HW23-T020	9-WG6G	25-300	25-120	24-CV7PR
1120FA												FA7TPR

JOBBER II 1121 & 1121FA

Medium Duty Outfits in Deluxe Tool Bag for General Purposes

- Can weld up to 5/64" and cut up to 1/2"
- Ideal for home, farm, construction, and industrial maintenance facilities
- With optional tips, can weld up to 1 1/4" and cut up to 6"
- Regulators come with Steel Gauge Guards
- 20' T-grade twin hoses
- 1121 is equipped with 24-CV7PR Torch End Check Valves
- 1121FA is equipped with FA7TPR Flashback Arrestors, which include built-in check valves
- Victor® Performer® equivalent



1121

Model Number	Dimension/Weight	Torch Handle	Cutting Attachment	Regulators	Cutting Tip	Welding Nozzles	T-Grade Twin Hoses	Goggles	Striker	Tip Cleaner	Check Valves
											Flashback Arrestors
1121	21"x19"x9" 19.8 lbs.	142T	142C	152X-80G (OXY.) 152Y-15G (ACET.)	172C-0	172W-0	HW23-T020	9-WG6G	25-300	25-120	24-CV7PR
1121FA											FA7TPR

Acetylene Regulator Inlet Connection supplied is standard CGA 510. Inlet connection CGA 300 is also available; to order, simply add "-3" to the outfit model number. For example: 1120-3 or 1120FA-3; 1121-3 or 1121FA-3.

Victor® and Performer® are a registered trademarks of Victor Equipment Co., which is not associated with Genstar Technologies Co., Inc.

IRON HORSE 1138 & 1138FA

Medium / Heavy Duty Outfits in Deluxe Tool Bag for General Purposes

- Can cut up to 3/4"
- Ideal for industrial and commercial applications
- With optional tips, can weld up to 3" and cut up to 6"
- 20' T-grade twin hoses
- 1138 is equipped with 24-CV7PR Torch End Check Valves
- 1138FA is equipped with FA7TPR Flashback Arrestors which include built-in check valves
- Victor® Contender® equivalent



1138

Model Number*	Dimension / Weight	Torch Handle	Cutting Attachment	Regulators	Cutting Tip	Heating Nozzle	T-Grade Twin Hoses	Goggles	Striker	Tip Cleaner	Check Valves	
											Flashback Arrestors	
1138	21"x19"x9" 23.3 lbs.	143T	143CA	853X-125 (OXY.) 853Y-15 (ACET.)	173C-1	173H-6	HW24-T020	9-WG6G	25-300	25-120	24-CV7PR	
1138FA											FA7TPR	

Acetylene Regulator Inlet Connection supplied is standard CGA 510. Inlet Connection CGA 300 is also available; to order, simply add "-3" to the outfit model number. For example: 1138-3 or 1138FA-3.

IRON HORSE II 1221

Medium / Heavy Duty Outfits in Deluxe Tool Bag for General Purposes

- Can weld up to 1/4" and cut up to 1/2"
- Ideal for ship building, construction, petroleum, and chemical industries
- With optional tips, can weld up to 1-1/4" and cut up to 6"
- 20' T-grade twin hoses
- 1221 is equipped with 24-CV7PR Torch End Check Valves
- Victor® Super Range® II equivalent



1221

Model Number*	Dimension / Weight	Torch Handle	Cutting Attachment	Regulators	Cutting Tip	Welding Nozzle	T-Grade Twin Hoses	Goggles	Striker	Tip Cleaner	Check Valves
1221	21"x19"x9" 21.5 lbs.	142T	142C	853X-125 (OXY.) 853Y-15 (ACET.)	172C-0	172W-2	HW24-T020	9-WG6G	25-300	25-120	24-CV7PR

Acetylene Regulator Inlet Connection supplied is standard CGA 510. Inlet Connection CGA 300 is also available; to order, simply add "-3" to the outfit model number. For example: 1221-3

COMMANDER 1130 & 1130FA

Heavy Duty Outfits in Deluxe Tool Bag for Industrial & Commercial Applications

- Can weld up to 1/2" and cut up to 3/4"
- Ideal for industrial and commercial applications
- With optional tips, can weld up to 3" and cut up to 8"
- Regulators come with Steel Gauge Guards
- 25' T-grade twin hoses
- 1130 is equipped with 24-CV7PR Torch End Check Valves
- 1130FA is equipped with FA7TPR Flashback Arrestors, which include built-in check valves
- Victor® Journeyman® equivalent



1130

Model Number*	Dimension / Weight	Torch Handle	Cutting Attachment	Regulators	Cutting Tip	Heating Nozzle	Welding Nozzles	T-Grade Twin Hoses	Goggles	Striker	Tip Cleaner	Check Valves	
												Flashback Arrestors	
1130	23"x22"x11" 28 lbs.	143T	143CA	153X-125G (OXY.) 153Y-15G (ACET.)	173C-1	173H-8	173W-1,3,5	HW24-T025	9-WG6G	25-300	25-120	24-CV7PR	
1130FA												FA7TPR	

COMMANDER II 1131 & 1131FA

Heavy Duty Outfits in Deluxe Tool Bag for Industrial & Commercial Applications

- Can weld up to 1/8" and cut up to 3/4"
- Ideal for industrial and commercial applications
- With optional tips, can weld up to 3" and cut up to 8"
- Regulators come with Steel Gauge Guards
- 20' T-grade twin hoses
- 1131 is equipped with 24-CV7PR Torch End Check Valve
- 1131FA is equipped with FA7TPR Flashback Arrestors, which include built-in check valves
- Victor® Journeyman® II equivalent



1131

Model Number*	Dimension / Weight	Torch Handle	Cutting Attachment	Regulators	Cutting Tip	Welding Nozzle	T-Grade Twin Hoses	Goggles	Striker	Tip Cleaner	Check Valves	
											Flashback Arrestors	
1131	23"x22"x11" 29 lbs.	143T	143CA	153X-125G (OXY.) 153Y-15G (ACET.)	173C-1	173W-2	HW24-T020	9-WG6G	25-300	25-120	24-CV7PR	
1131FA											FA7TPR	

Acetylene Regulator Inlet Connection supplied is standard CGA 510. Inlet Connection CGA 300 is also available; to order, simply add "-3" to the outfit model number. For example: 1130-3 or 1130FA-3; 1131-3 or 1131FA-3.

Victor® & Journeyman® are registered trademarks of Victor Equipment Co., which is not associated with Genstar Technologies Co., Inc.

EXCALIBUR 4121 & 4121FA

Medium Duty Outfits in Deluxe Tool Bag for All Trades

- Can weld up to 1/8" and cut up to 1"
- Ideal for ship building, construction, petroleum, and chemical industries
- With optional tips, can weld up to 1/2" and cut up to 5"
- 20' T-grade twin hoses
- 4121 is equipped with 24-CV7PR Torch End Check Valves
- 4121FA is equipped with FA7TPR Flashback Arrestors, which include built-in check valves
- Harris® Steelworker® Classic equivalent



4121

Model Number*	Dimension / Weight	Torch Handle	Cutting Attachment	Regulators	Cutting Tip	Welding Elbow	Mixer	T-Grade Twin Hoses	Goggles	Striker	Check Valves
											Flashback Arrestors
4121	21"x19"x9" 19 lbs.	442T	442C	452X-80 (OXY.) 452Y-15 (ACET.)	472C-1	472W-5	472M	HW23-T020	9-WG6G	25-300	24-CV7PR
4121FA											FA7TPR

THE BOSS 4131 & 4131FA

Heavy Duty Outfits in Deluxe Tool Bag for Industrial & General Purposes

- Can weld up to 1/8" and cut up to 1"
- Designed for all trades. Features a complete package of apparatus and accessories for general purpose and industrial use
- With optional tips, can weld up to 1" and cut up to 6"
- 20' T-grade twin hoses
- 4131 is equipped with 24-CV7PR Torch End Check Valves
- 4131FA is equipped with FA7TPR Flashback Arrestors, which include built-in check valves
- Harris® Pipeliner® Classic equivalent



4131

Model Number*	Dimension / Weight	Torch Handle	Cutting Attachment	Regulators	Cutting Tip	Welding Elbow	Mixer	T-Grade Twin Hoses	Goggles	Striker	Check Valves
											Flashback Arrestors
4131	23"x22"x11" 22.5 lbs.	443T	443C	453X-175 (OXY.) 453Y-15 (ACET.)	472C-1	472W-5	473M	HW24-T020	9-WG6G	25-300	24-CV7PR
4131FA											FA7TPR

Acetylene Regulator Inlet Connection supplied is standard CGA 510. Inlet connection CGA 300 is also available; to order, simply add "-3" to the outfit model number. For example: 4121-3 or 4121FA-3.

Harris® Steelworker® & Pipeliner are registered trademarks of Lincoln Equipment Co., which is not associated with Genstar Technologies Co., Inc.

TOTE A TORCH 12-PT, 12-PTC & 12-PTCSP

Portable Outfit for Repair & Maintenance

- Can weld up to 3/16" and cut up to 1/2". With optional larger tips and sufficient acetylene and oxygen supply
- Tote-A-Torch can weld up to 1-1/4" and cut up to 6"
- A light to medium duty portable outfit that is extremely popular for general maintenance work, metal sculpture, automotive repair, air conditioning, refrigeration, etc. The carrier is made of tough, lightweight polypropylene and is designed to carry one "MC" acetylene cylinder, one "R" (20 cu. ft.) oxygen cylinder, and apparatus
- Featured with this outfit are rear entry regulators for better balance on the small cylinders. The acetylene regulator has an "MC" (CGA 200) inlet connection and the oxygen regulator has the standard CGA 540 connection
- Torch handle is equipped with 24-CV7PR torch end check valves
- Regulators come with rubber gauge guards
- 12-PTCSP is the 12-PTC outfit with Anti-Theft skin package
- 3/16" x 12.5' T-grade twin hoses
- The outfit is available with or without cylinders. See chart below
- The rugged molded plastic carrier (CRT10) is also available separately
- Victor® Portable Torch equivalent



12-PTCSP



12-PTC

Model Number	Dimension / Weight	Torch Handle	Cutting Attachment	Regulators Oxygen / Acetylene	Cutting Tip	Welding Nozzle	Twin Hoses	Goggles	Striker	Plastic Carrier	Cylinders Oxygen / Acetylene
12-PT	24.5"x11"x11" 13.4 lbs.	142T	142C	210X-80G / 210Y-15G	172C-0	172W-1	HW23-T012	9-WG6G	25-300	CRT10	N/A
12-PTC	24.5"x11"x11" 36 lbs.										CY20-540 / CY10-MC
12-PTCSP	24.5"x11"x11" 36.4 lbs.										CY20-540 / CY10-MC

Victor® is a registered trademark of Victor Equipment Co., which is not associated with Genstar Technologies Co., Inc.

13-0S Series Cutting Outfits

- Can cut up to 8"
- Ideal for industrial & commercial application
- Great for users who prefer the "combo" torch handle and cutting attachment, which offers a sensitive touch control of the cutting oxygen valve
- Welding and heating nozzles can also be utilized
- Victor® Journeyman® "Select" compatible
- Outfits equipped with check valves or flashback arrestors



13-0S

Model Number	Torch Handle	Cutting Attachment	Regulators Oxygen / Acetylene	Check Valves
				Flashback Arrestors
13-0S	143T	143CA	153X-125 / 153Y-15	24-CV7PR
13-0SFA				FA7TPR
13-0SA	143T	143ACA	153X-125 / 153Y-15	24-CV7PR
13-0SAFA				FA7TPR

63L-4 & 63L-5 Series Cutting Outfits

- Can cut up to 12"
- Ideal for industrial & commercial application
- Features a 21" torch with choices of the 452 series medium/heavy duty regulators or the top of the line 153 series heavy duty regulators
- Victor® "Cutter Select" compatible
- Equipped with check valves or flashback arrestors



63L-4



63L-5

Model Number	21" Cutting Torch	Regulators Oxygen / Acetylene	Check Valves
			Flashback Arrestors
63L-4	163L-21	452X-80 / 452Y-15	24-CV7PR
63L-4FA			FA7TPR
63L-5	163L-21	153X-125 / 153Y-15	24-CV7PR
63L-5FA			FA7TPR

Victor® and Journeyman® are registered trademarks of Victor Equipment Co., which is not associated with Genstar Technologies Co., Inc.

TORCH HANDLES

MODEL 143T ILLUSTRATED



FORGED BRASS HEAD
for durability

RIBBED BARREL
provides sure grip



TUBE-IN-A-TUBE-DESIGN
has greater wall thickness
for higher handle strength



DENSE DIE FORGED BRASS BODY
threaded for easy service

CONTROL VALVES
have Teflon® packing for
smooth, gas-tight operation

GENTEC® Torch Handles are available in light, medium, and heavy duty models. Torch handles are machined from high-quality forged brass. Threaded construction facilitates easy repairs and services.

- 140T, 141T, 142T and 143T Series feature Tube-in-a-Tube design within each torch handle
- 342T Series features Gas Saver On/Off Lever, which is designed for immediate On/Off control of the oxygen and fuel gases for precise gas control. The pilot adjustment allows for maintaining a small pilot flame for immediate acceleration of the flame on the brazing tip. 342T-Y is used with Acetylene/MAPP® and 342T-F is used with other fuel gases
- 442T and 443T both feature 2 tubes within each torch handle

Model Number	Welding Range	Weight / Length	Victor® Equivalent	Uses Cutting Attachment	Uses Welding Nozzle	Uses Heating Nozzle
140T	1-1/4"	8-1/2 oz. 6"	J-28	141C	171W, 871W, 881W G17-VMA-1 GMTW, GMTT GMTR, G17-FT G13-8VM, G17	171H 171HN
141T	1-1/4"	13.3 oz. 7-3/4"	J-100C	141C	171W, 871W, 881W G17-VMA-1 GMTW, GMTT GMTR, G17-FT G13-8VM, G17	171H 171HN
141TA						
142T	1-1/4"	13.4 oz. 7-3/4"	100C	142C	172W 172WRTE 872W	172H 172HN 872H
143T	3"	1 lb. 2 oz. 8-1/2"	315C	143CA 143ACA 143SCA	173W 173WRTE 173WRTE 873W 883W	173H 173HN 175HN 873H
143TL		1 lb. 5 oz. 11"	310C			
143TLH		1 lb. 12 oz. 11"	HD310C			

Victor® is a registered trademark of Victor Equipment Co., MAPP® is a registered trademark of BOC Group Inc., Teflon® is a registered trademark of E.I. DuPont de Nemours & Co. These companies are not associated with Genstar Technologies Co., Inc.



140T Light Duty
("A" size hose fitting)



141T Light Duty
141TA Light Duty
("A" size hose fitting)



142T Medium Duty



143T Heavy Duty



143TL Heavy Duty



143TLH Extra Heavy Duty

Pilot Flame Function Torch



342T-Y Light Duty



342T-F Light Duty

Model Number	Welding Range	Weight / Length	Uses Cutting Attachment	Uses Welding Nozzle	Uses Heating Nozzle
342T-Y	1/2"	0.7 lb. 6-5/8"	141C	171W, 871W, 881W G17-VMA-1 GMTW, GMTT GMTR, G17-FT G13-8VM	171H
342T-F	1/2"	0.7 lb. 7-3/4"	141C	G17 881W	171HN

Note: When using heating nozzles and cutting attachment, the Pilot Flame Function should not be used. Available with torch end check valves (add "-CV" to model number) or flashback arrestors (add "-FA" to model number)



442T Medium Duty



443T Heavy Duty

Model Number	Welding Range	Weight / Length	Harris® Equivalent	Uses Cutting Attachment	Uses Welding Elbow / Mixer	Uses Heating Nozzle
442T	1/2"	13.5 oz. 7-3/4"	85	442C	472W / 472M	472H-2
443T	1/2"	1.4 lbs. 9-1/2"	43-2	443C	472W / 473M	472H-2

Harris® is a registered trademarks of Lincoln Electric Co., which is not associated which Genstar Technologies Co., Inc.

CUTTING ATTACHMENTS

Industrial Gas Apparatus

**MODEL 143ACA
ILLUSTRATED**



**STAINLESS STEEL
TUBES**
for strength & long life

**STAINLESS STEEL
OXYGEN LEVER**
for durability

FORGED BRASS HEAD
for durability

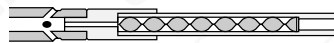

SPIRAL MIXER
gives optimum mix
of fuel & oxygen

**BRASS COUPLING NUT
AND DOUBLE O-RING SEAL**
gives quick, hand tight, & leak-
free operation



GENTEC® Cutting Attachments are made from high quality die-forged brass and stainless steel components. They are available in light, medium, and heavy duty models. Featuring drop-in tube mixer design, 141C, 142C, 143CA, 143ACA and 143SCA can be used with acetylene, propane, MAPP®, propylene, fuel gas, and natural gas (2 PSIG & above). 442C and 443C, both featuring a flat seat tip design and an in-head mixer, have three tubes in a triangular arrangement.

Model Number	Cutting Range	Head Angle	Weight / Length	Victor® Equivalent	Uses Torch Handle	Uses Cutting Tip
141C	3"	90°	13.8 oz. 8-1/4"	CA1260	140T, 141T 141TA, 342T	172C, 172CN 172CP, 172CG
142C	6"	90°	14 oz. 8-1/4"	CA1350	142T	172C, 172CN 172CP, 172CG
143CA	8"	90°	1 lb. 14 oz. 10-5/8"	CA2460	143T, 143TL 143TLH	173C, 173CN, 173CP 173CM, 173CG, 173CGN
143ACA		75°		CA2461		
143SCA		180°		CA2462		



141C Light Duty



142C Medium Duty



143CA Heavy Duty



143ACA Heavy Duty



143SCA Heavy Duty

Model Number	Cutting Range	Head Angle	Weight / Length	Harris® Equivalent	Uses Torch Handle	Uses Cutting Tip
442C	5"	90°	1.5 lbs. 9-1/2"	72-3	442T	472C 472CN
443C	6"	90°	1.5 lbs. 9-1/2"	73-3	443T	472C 472CN



442C Medium Duty



443C Heavy Duty

Harris® is a registered trademark of Lincoln Electric Co., which is not associated with Genstar Technologies Co., Inc.

HAND CUTTING TORCHES

Industrial Gas Apparatus

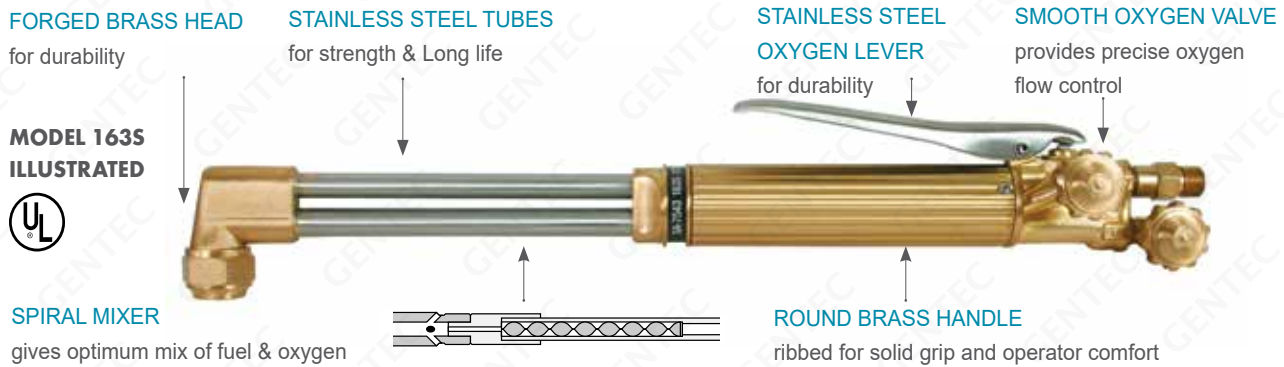

GENTEC® Hand Cutting Torches are machined from high-quality forged brass and stainless steel components. 161S and 163 Series feature drop-in tube mixer design. 162 Series has a triangular tube arrangement and an in-head mixer. 263 and 363S series have inline tube arrangements and can be used with any type of fuel gas, such as acetylene, propane, natural gas, propylene, and MAPP (2 PSIG and above). 463 Series has a triangular tube arrangement, in-head mixer, and models available for oxy-acetylene and oxy-propane cutting operations. Its balanced design and rugged construction are ideal for medium/heavy duty cutting and scraping operations.

161 Series



161S-17 Medium Duty

Model Number	Cutting Range	Head Angle	Weight / Length	Victor® Equivalent	Uses Cutting Tip
161S-17	6"	90°	1 lb. 10 oz. / 17"	CST800C	172C, 172CN 172CP, 172CG

Note: Available with torch end check valves (add "-CV" to model number) or flashback arrestors (add "-FA" to model number)

162 Series



162L-21 Medium Duty

Model Number	Cutting Range	Head Angle	Weight / Length	Victor® Equivalent	Uses Cutting Tip
162S-17	6"	90°	2.15 lbs. / 17"	SST900C	173C, 173CN 173CP, 173CM 173CG, 173CGN
162L-21	6"	90°	2.25 lbs. / 21"	ST900C	

Note: Available with torch end check valves (add "-CV" to model number) or flashback arrestors (add "-FA" to model number)

163 Series



163L-21 Heavy Duty

Model Number	Cutting Range	Head Angle	Weight / Length	Victor® Equivalent	Uses Cutting Tip
163S-17	14"	90°	3 lbs. / 17"	SST1600C (SST2600)	173C 173CN 173CP 173CM 173CG 173CGN
163L-21			3.3 lbs. / 21"	ST1600C (ST2600)	
163L-27			3.7 lbs. / 27"	ST1610C (ST2610)	
163L-36			4.3 lbs. / 36"	ST1630C (ST2630)	
163L-48			5 lbs. / 48"	ST1650C (ST2650)	
163AL-21	14"	75°	3.4 lbs. / 21"	ST1601C (ST2601)	
163AL-27			3.8 lbs. / 27"	ST1611C (ST2611)	
163AL-36			4.3 lbs. / 36"	ST1631C (ST2631)	
163AL-48			5 lbs. / 48"	ST1651C (ST2651)	
163SL-21	14"	180°	3.5 lbs. / 21"	ST1602C (ST2602)	
163SL-27			3.8 lbs. / 27"	ST1612C	
163SL-36			4.3 lbs. / 36"	ST1632C (ST2632)	
163SL-48			5 lbs. / 48"	ST1652C (ST2652)	

Note: Available with torch end check valves (add "-CV" to model number) or flashback arrestors (add "-FA" to model number)

MAPP® is a registered trademark of BOC Group, Inc., Victor® is a registered trademark of Victor Equipment Co. These companies are not associated with Genstar Technologies Co., Inc.

263 Series



263S-18 Medium Duty

Model Number	Cutting Range	Weight / Length	Uses Cutting Tip
263S-18	12"	2 Lbs. / 18"	672C, 673C AIRCO® STYLE CUTTING TIPS
263L-21	12"	2 Lbs. 4 oz. / 21"	

Note: Available with torch end check valves (add "-CV" to model number) or flashback arrestors (add "-FA" to model number)

363 Series



363S-18 Heavy Duty

Model Number	Cutting Range	Weight / Length	Uses Cutting Tip
363S-18	14"	2 lbs. 7 oz. / 18"	672C, 673C AIRCO® STYLE CUTTING TIPS

Note: Available with torch end check valves (add "-CV" to model number) or flashback arrestors (add "-FA" to model number)

463 Series for Oxy-Acetylene Only



463E-18 Medium / Heavy Duty



463EL-21 Medium / Heavy Duty

Model Number	Cutting Range	Head Angle	Weight / Length	Harris® Equivalent	Uses Cutting Tip
463AE-18	12"	70°	3 lbs. / 18"	62-5AE	472C
463AE-21			3.1 lbs. / 21"	62-5AEL (21")	
463AE-36			4.1 lbs. / 36"	62-5AEL (36")	
463E-18	12"	90°	3 lbs. / 18"	62-5E	472C
463EL-21			3.6 lbs. / 21"	62-5EL (21")	
463EL-36			4.1 lbs. / 36"	62-5EL (36")	
463SE-18	12"	180°	3 lbs. / 18"	N/A	472C
463SE-21			3.1 lbs. / 21"		
463SE-36			4 lbs. / 36"		

Note: 48" and 72" are available for special order. Available with torch end check valves (add "-CV" to model number) or flashback arrestors (add "-FA" to model number)

463 Series for Oxy-Fuel Gases Only



463FL-36 Medium / Heavy Duty

Model Number	Cutting Range	Head Angle	Weight / Length	Harris® Equivalent	Uses Cutting Tip
463AF-18	12"	70°	3.3 lbs. / 18"	62-5AF	472CN
463AF-21			3.4 lbs. / 21"	62-5AFL (21")	
463AF-36			4 lbs. / 36"	62-5AFL (36")	
463F-18	12"	90°	3.3 lbs. / 18"	62-5F	472CN
463FL-21			3.4 lbs. / 21"	62-5FL (21")	
463FL-36			4 lbs. / 36"	62-5FL (36")	
463SF-18	12"	180°	3 lbs. / 18"	62-5BF	472CN
463SF-21			3.3 lbs. / 21"	62-5BFL (21")	
463SF-36			4.2 lbs. / 36"	62-5BFL (36")	

Note: 48" and 72" are available for special order. Available with torch end check valves (add "-CV" to model number) or flashback arrestors (add "-FA" to model number)

Airco® is a registered trademark of Airco Welding Products Div. of BOC Group, Inc., Harris® is a registered trademark of Lincoln Electric Co. These companies are not associated with Genstar Technologies Co., Inc.

MACHINE CUTTING TORCHES

Industrial Gas Apparatus

GENTEC® Machine Cutting Torches are designed to handle all applications of machine cutting. They are available in two-hose and three-hose versions. They can be used with various fuel gases, such as Acetylene, Propane, Natural Gas, Propylene, and MAPP.

- High quality die-forged brass
- Stainless Steel Tubes for strength and durability
- Standard 1-3/8" diameter barrel
- Four-position rack adjustment with 90° intervals
- 32 pitch rack
- Equipped with a pair of reverse flow check valves (Model 24-CV7TPR) on inlet connections for operational safety
- Two-hose version is available in MC200 models. Three-hose version is available in MC100 and MC300 models
- Compatible with Victor® Style cutting tips



For Acetylene and Other Pressurized Gases

Series	Model Number	Cutting Range	Barrel Length	Racking Length	Uses Cutting Tip	
MC100	MC105A	10"	5-1/2"	N/A	173C	
	MC105AR		5-1/2"	4-1/2"		
MC200	MC205A	8"	5-1/2"	N/A		
	MC205AR		5-1/2"	4-1/2"		173CN
	MC210A		10"	N/A		173CHP
	MC210AR		10"	7"		173CHN
MC300	MC310A	12"	10"	N/A		173CP
	MC310AR		10"	7"		
	MC318A		18"	N/A		
	MC318AR		18"	15"		

For All Fuel Gases Except Acetylene

Series	Model Number	Cutting Range	Barrel Length	Racking Length	Uses Cutting Tip
MC100	MC105F	10"	5-1/2"	N/A	173CN 173CHP 173CHN 173CP
	MC105FR		5-1/2"	4-1/2"	
MC200	MC205F	8"	5-1/2"	N/A	
	MC205FR		5-1/2"	4-1/2"	
	MC210F		10"	N/A	
	MC210FR		10"	7"	
MC300	MC310F	12"	10"	N/A	
	MC310FR		10"	7"	
	MC318F		18"	N/A	
	MC318FR		18"	15"	

Replacement Racks with Installation Screws

Model Number	Length
MT100-16	4-1/2"
MT200-16	7"
MT300-16	15"

■ Oxy-Acetylene



173MFTA-10
173MFTA-12

■ Oxy-Fuel



173MFTN-10
173MFTN-12

Adjustable Head (0-90) °



MC-BCHA

Preheat Attachment for MC-HT-BCHA

■ For Adjustable Head



MC-HT-BCHA

MAPP® is a registered trademark of BOC Group, Inc., Victor® is a registered trademark of Victor Equipment Co. These companies are not associated with Genstar Technologies Co., Inc.

Check Valves

Torch End Check Valves

24-CV5PR Pair



OXYGEN
24-CV5TO

FUEL
24-CV5TF

Torch End Check Valves

24-CV7PR Pair



OXYGEN
24-CV7TO

FUEL
24-CV7TF

Regulator Bushing Check Valves

24-CV8PR Pair



OXYGEN
24-CV8RO

FUEL
24-CV8RF

Regulator Bushing Adapter Check Valves

24-CV9PR Pair



OXYGEN
24-CV9RO

FUEL
24-CV9RF

GENTEC® Check Valves prevent reverse flow of gases which can cause dangerous mixtures. Choose from four styles to fit your needs: 24-CV5 series check valves are attached to the torch ends with “A” size fittings; 24-CV7 series check valves are attached to the torch ends with “B” size fittings; 24-CV8 series check valves replace the standard “B” size outlet bushings on regulators; 24-CV9 series check valves attach to the “B” size outlet bushings on the regulators.

Note: Check valves are not flashback arrestors and should not be used as such! Whichever check valve type you may choose, torch end, regulator bushing, or regulator bushing adapter, GENTEC® recommends the use of check valves between the torch and the regulator at all times.

Quick Connectors

GENTEC® Quick Connectors

provide fast, reliable, and easy setup for welding, cutting, and brazing applications. They ensure pressure-tight connections made in seconds.

Regulator-To-Hose Pair

QC-RHPR-A (A FITTING)
QC-RHPR (B FITTING)



QC-RHF-A (A FITTING)
QC-RHF (B FITTING)
For Fuel Gases



QC-RHX-A (A FITTING)
QC-RHX (B FITTING)
For Oxygen

Hose-To-Hose Quick Pair

QC-HHPR-A (A FITTING)
QC-HHPR (B FITTING)



QC-HHF-A (A FITTING)
QC-HHF (B FITTING)
For Fuel Gases



QC-HHX-A (A FITTING)
QC-HHX (B FITTING)
For Oxygen

Hose-To-Torch Pair

QC-HTPR (B FITTING)



QC-HTF (B FITTING)
For Fuel Gases



QC-HTX (B FITTING)
For Oxygen

- Built-in automatic reset check valves prevent reverse flow of gas by cutting off the gas under back pressure
- Oxygen and Fuel gas models are not interchangeable in order to prevent wrong connections
- Maximum working pressure: 29 PSI for fuel gases, 145 PSI for oxygen
- Gas must be shut off at regulators when disconnected
- Color-coded for fast, efficient, and safe handling
- 9/16"-18 (B Fitting) connections for all models
- 3/8"-24 (A Fitting) for Regulator-To-Hose and Hose-To-Hose models

Type	Pair Model Number	Single Model Number	Gas Service	Component Model Number (Female Socket/Male Plug)	Connection
Regulator To Hose (A Fitting 3/8"-24)	QC-RHPR-A	QC-RHF-A	Fuel	QC-RHF-F-A / QC-RHF-M-A	3/8"-24LH
		QC-RHX-A	Oxygen	QC-RHX-F-A / QC-RHX-M-A	3/8"-24RH
Hose To Hose (A Fitting 3/8"-24)	QC-HHPR-A	QC-HHF-A	Fuel	QC-HHF-F-A / QC-HHF-M-A	3/8"-24LH
		QC-HHX-A	Oxygen	QC-HHX-F-A / QC-HHX-M-A	3/8"-24RH
Regulator To Hose (B Fitting 9/16"-18)	QC-RHPR	QC-RHF	Fuel	QC-RHF-F / QC-RHF-M	9/16"-18LH
		QC-RHX	Oxygen	QC-RHX-F / QC-RHX-M	9/16"-18RH
Hose To Hose (B Fitting 9/16"-18)	QC-HHPR	QC-HHF	Fuel	QC-HHF-F / QC-HHF-M	9/16"-18LH
		QC-HHX	Oxygen	QC-HHX-F / QC-HHX-M	9/16"-18RH
Hose To Torch (B Fitting 9/16"-18)	QC-HTPR	QC-HTF	Fuel	QC-HTF-F / QC-HTF-M	9/16"-18LH
		QC-HTX	Oxygen	QC-HTX-F / QC-HTX-M	9/16"-18RH

FLASHBACK ARRESTORS



GENTEC® Flashback Arrestors are specially designed to prevent personal injury and damage to equipment from severe flashbacks. GENTEC® flashback arrestors are available for regulators, torches, and pipes.

- Outlet connection: 9/16"-18LH and 3/8"-24LH are for Acetylene and Fuel gas models; 9/16"-18RH and 3/8"-24RH are for Oxygen models; 3/8"-24LH and 3/8"-24RH are available for torches and regulators only
- Sintered Metal Flame Arresting Filter quenches the flame from severe flashbacks
- Built-in automatic reset Check Valve prevents the reverse flow of gas by temporarily cutting off the gas
- FA10 and FA20 Series are equipped with a Heat Sensitive Cut-off Valve which automatically shuts off gas supply and cannot be reset
- FA23 Series is equipped with a Pressure Sensitive Cut-off Valve, which automatically shuts off gas supply and can be manually reset, and a Pressure Relief Valve, which relieves excess pressure and fumes in the event of a flashback

Pair Model Number	Single Model Number	Fits	Gas Service	Working Pressure (PSI)	Flow Capacity (SCFH)	Connection	Equipped
FA5TPR	FA5TF	Torch	Acetylene, Fuel	15	70	3/8"-24LH	Check Valve
	FA5TO		Oxygen	145	706	3/8"-24RH	
FA5RPR	FA5RF	Regulator	Acetylene, Fuel	15	70	3/8"-24LH	Check Valve
	FA5RO		Oxygen	145	706	3/8"-24RH	
FA7TPR	FA7TF	Torch	Acetylene, Fuel	15	70	9/16"-18LH	Check Valve
	FA7TO		Oxygen	145	706	9/16"-18RH	
FA7RPR	FA7RF	Regulator	Acetylene, Fuel	15	70	9/16"-18LH	Check Valve
	FA7RO		Oxygen	145	706	9/16"-18RH	
N/A	FA10RF	Regulator	Acetylene, Fuel	15	350	9/16"-18LH	Check Valve Thermal Cut-Off
	FA10RO		Oxygen	145	1060	9/16"-18RH	
N/A	FA20PF	Pipe	Acetylene, Fuel	15	350	9/16"-18LH	Check Valve Thermal Cut-Off
	FA20PO		Oxygen	145	1240	9/16"-18RH	
N/A	FA23RF	Regulator	Acetylene, Fuel	15	350	9/16"-18LH	Check Valve Pressure Relief & Pressure Cut-Off
	FA23RO		Oxygen	145	1410	9/16"-18RH	

Oxy-Acetylene & Oxy-Hydrogen Welding Nozzles

- Red copper tip ends
- Ideal for soldering, brazing, heating, hardfacing, etc.
- 171W, 172W, and 173W use one-piece elbow tips
- Victor® compatible

Nozzle Series	Victor® Equivalent	Sizes Available	Fits Torch Handles	Type
171W	W-J	000-6	140T, 141T 141TA, 342T-Y 10CM (000-0)	1 PIECE
172W	W-1		142T	
173W	W		143T 143TL 143TLH	



Welding Elbows & Mixers of 171W, 172W & 173W

Elbow Series	Victor® Equivalent	Sizes Available	Mixer Model Number	Victor® Equivalent	Fits Torch Handles	Nozzle Series
871W		000-4	871M	4-UM-J	140T, 141T 141TA, 342T-Y 10CM (000-0)	171W
		5, 6	871M-7	7-UM-J		
872W	ET	000-2	872M	4-UM-1	142T	172W
	ET-1	3, 4		7-UM-1		
872W	ET	000-2	873M	2-UM	143T 143TL 143TLH	173W
873W	ET	3, 4	873M-4	4-UM		
		5, 6	873M-6	6-UM		

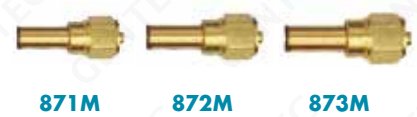

Oxy-Acetylene Welding Elbows & Mixers

- Red copper tip ends
- Ideal for soldering, brazing, heating, hardfacing, etc.
- Harris® compatible

Elbow Series	Harris® Equivalent	Sizes Available	Mixer Model Number	Harris® Equivalent	Fits Torch Handle
472W	23A90	0-8	472M	D-85	442T
			473M	E-43	443T



Harris® is a registered trademark of The Lincoln Electric Co., Victor® is a registered trademark of Victor Equipment Co. These companies are not associated with Genstar Technologies Co., Inc.

Multi-Gas Welding Nozzles

- Replaceable tip ends
- Ideal for brazing and heating
- Victor® compatible



Nozzle Series	Gas Service	Victor® Equivalent	Sizes Available	Type	Fits Torch Handles
173WRTE	OXY-ACET.	RTE	0-6	2 PIECE	143T, 143TL 143TLH
G17	OXY-FUEL	UN-J+TEN	0-6	2 PIECE	140T, 141T 141TA, 342T-F
172WRTEN		UN-1+TEN	0, 2, 4, 6	2 PIECE	142T
173WRTEN		RTE	0, 2, 4, 6, 8	2 PIECE	143T, 143TL 143TLH

Multi-Gas Welding Elbows

Model Number	Victor® Equivalent	Fits Torch Handle	Fits Tip End Number
881W	UN-J	140T, 141T 141TA, 342T	883TE-0~5 883TEN-0~5 883TEMFA-1~5
881W-TT	N/A		
882W	UN-1	142T	
883W	UN	143T 143TL 143TLH	

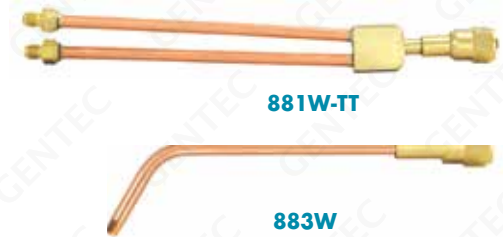

Multi-Gas Welding Replacement Tip Ends



883TE



883TEMFA



883TEN



883TEMFN

Tip End Series	Gas Service	Victor® Equivalent	Sizes Available	Thread	Fits Elbows & Nozzles
883TE	OXY-ACET.	TE	0-5	5/16"-27	881W, 881W-TT, 882W, 883W, 173WRTE -0~5
			6	0.393"-27	173WRTE-6
883TEMFA	OXY-ACET.	TEMFA	1-5	5/16"-27	881W, 881W-TT, 882W, 883W
883TEN	OXY-FUEL	TEN	0-5	5/16"-27	881W, 881W-TT, 882W, 883W, 172WRTEN -0, 2, 4, 173WRTEN -0, 2, 4
			6, 8	0.393"-27	172WRTEN-6, 173WRTEN-6, 8
883TEMFN	OXY-FUEL	TEMFN	5	5/16"-27	881W, 881W-TT, 882W, 883W

Victor® is a registered trademark of Victor Equipment Co., which is not associated with Genstar Technologies Co., Inc.

Mini-Style Oxy-Acetylene Brazing Tips

Mini-Style Oxy-Acetylene Brazing Tips, rugged and short, are designed to provide precise and concentrated heat up to 6000°F.

Model Number	Brazing Capacity	Overall Length	Fits Torch Handles
GMTW-1	1/2"	3"	140T, 141TA, 342T-Y, 10CM
GMTW-2	1"	3"	
GMTT	1"	4"	
GMTR	1-1/2"	4"	

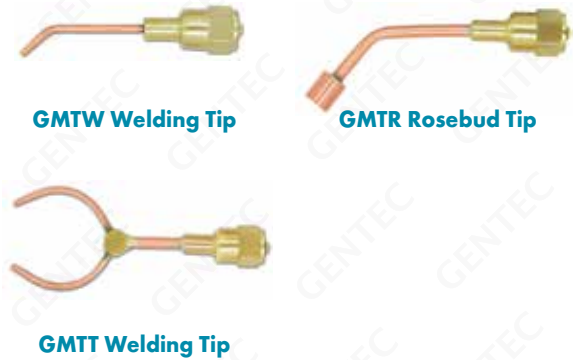

Flexible Oxy-Acetylene Brazing Tips

G17-FT Flexible Brazing Tip has a 9" long flexible elbow that can be shaped to provide flexibility for various flame positions. It can be reshaped for the next application.

Model Number	Fits Torch Handles
G17-FT	140T, 141TA, 342T-Y

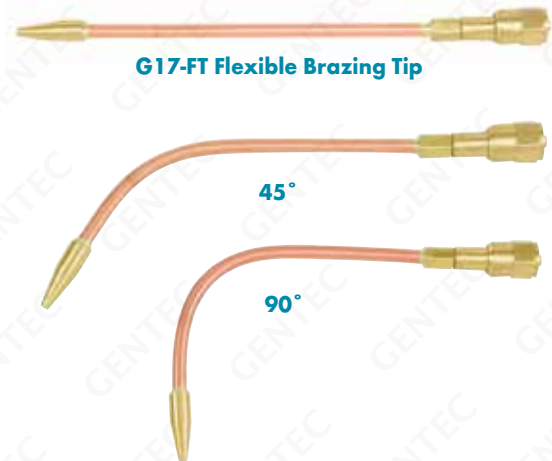

G13-8VM Flexible Twin Heating Tip has two flexible elbows that can be shaped to provide flexibility for various flame positions. It can be reshaped for the next application.

Model Number	Fits Torch Handles
G13-8VM	140T, 141TA, 342T-Y



G17-VMA-1 Oxy-Acetylene Rosebud tip is a multi-flamed tip designed for soldering, brazing, and heating in confined areas.

Model Number	Fits Torch Handles	Size Available
G17-VMA-1	140T, 141TA, 342T-Y	1



Oxy-Acetylene & Oxy-Hydrogen Heating Nozzles

- Ideal for preheating, straightening, etc.
- 173H-12 and 173H-15 are also used for propylene based fuel gases and MAPP
- G17-VMA-1 is designed for heating in confined areas
- Victor® compatible

Nozzle Series	Victor® Equivalent	Sizes Available	Fits Torch Handles
G17-VMA-1	VMA-1-15	1	140T, 141T, 141TA, 342T-Y
171H	MFA-J	2, 4, 6	140T, 141T, 342T-Y
172H	MFA-1	2, 4, 6, 8	142T
173H	MFA	4, 6, 8, 10, 12, 15	143T, 143TL, 143TLH

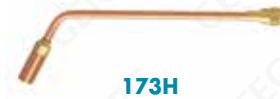

Heating Elbows & Mixers of 171H, 172H & 173H

Elbow Series	Sizes Available	Mixer Model Number	Nozzle Series	Fits Torch Handles
871H	2, 4, 6	871M-7	171H	140T, 141T, 141TA, 342T-Y
872H	2, 4, 6	872M	172H	142T
	8	873M-7		
873H	4, 6, 8, 10, 12, 15	873M-10	173H	143T, 143TL, 143TLH



Oxy-Propane, Oxy-Propylene & Oxy-Natural Gas Heating Nozzles

- Ideal for preheating, straightening, etc.
- Heavy swaged copper tip with recessed face

Nozzle Series	Victor® Equivalent	Sizes Available	Fits Torch Handles
171HN	MFN-J	6, 8	140T, 141T, 141TA, 342T-Y
172HN	MFN-1	6, 8	142T
173HN	MFN	8, 10, 12, 15, 20	143T, 143TL, 143TLH



Victor® is a registered trademark of Victor Equipment Co., which is not associated with Genstar Technologies Co., Inc.

Oxy-Acetylene Heating Elbows & Mixers

- Ideal for preheating & straightening
- Harris® compatible



Model Number	Harris® Equivalent	Size Available	Mixer Model Number	Harris® Equivalent	Fits Torch Handles
472H-2	J-63-2	2	472M	D-85	442T
			473M	E-43	443T

175HN Fuel Gas (Except Acetylene) Heating Nozzles

- Use with any fuel gas except acetylene
- Components of 175HN series are available
- Replaceable red copper heating tips for longer service
- Threaded elbows provide the extension of these nozzles
- Ideal for pre-heating, straightening, etc.
- Victor® type 55 compatible



Nozzle Series	Victor® Equivalent	Sizes Available	Fits Torch Handles	Total Length
175HN	TYPE 55	10, 15, 20	143T 143TL 143TLH	28"

Heating Elbows



Model Number	Length	Angle	Fits Torch Handles
875HEL-14	14"	65°	143T 143TL 143TLH
875HEL-26	26"	65°	
875HEL-28	28"	180°	

Heating Head & Mixer



Head Series	Sizes Available	Mixer Model Number
875HRB	10, 15, 20	876M

Victor® is a registered trademark of Victor Equipment Co., Harris® is a registered trademark of The Lincoln Electric Co. These companies are not associated with Genstar Technologies Co., Inc.

GENTEC® Cutting Tips are precision machined from high quality copper alloys for durability. The gas passages for single-piece acetylene tips are accurately swage-formed and shaped on polished mandrels for smooth and efficient gas flow. Dual-piece tips, featuring an internal spline configuration are designed for alternate fuel gases, and offer the optimum in cutting performance. High speed cutting tips feature stainless steel insert core for longer life. All tips are 100% flame tested.

Victor® Style Cutting Tips

Tip Series	Victor® Equivalent	Sizes Available	Type	Gases
172C	3-101	000-6	1 PIECE	ACETYLENE
172CN	3-GPN	000-5	2 PIECE	NATURAL GAS/PROPANE
172CP	3-GPP	0, 1, 2	2 PIECE	PROPYLENE/MAPP®
173C	1-101	000-8	1 PIECE	ACETYLENE
173CN	GPN	000-8	2 PIECE	NATURAL GAS/PROPANE
173CP	GPP	00-5	2 PIECE	PROPYLENE/MAPP®
173CM	GPM	0, 1, 2	2 PIECE	MAPP®



Victor® Style Scarfing - Gouging Tips

Tip Series	Victor® Equivalent	Sizes Available	Type	Gases
172CG	3-118	2	1 PIECE	ACETYLENE
173CG	1-118	0, 2, 4	1 PIECE	ACETYLENE
173CGN	1-234	2	1 PIECE	NATURAL GAS/PROPANE

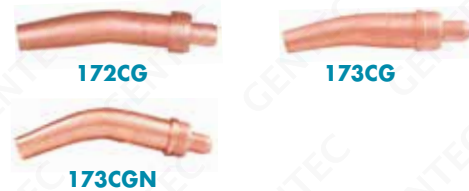

Victor® Style Machine Torch High Speed Cutting Tips

Stainless Steel Inner Core

Tip Series	Victor® Equivalent	Sizes Available	Type	Gases
173CHP	MTHP	00-4	2 PIECE	PROPYLENE/MAPP®
173CHN	MTHN	00-6	2 PIECE	NATURAL GAS/PROPANE



Victor® Style Machine Torch Heating Tips

Tip Series	Victor® Equivalent	Sizes Available	Type	Gases
173MFTA	MFTA	10,12	1 PIECE	ACETYLENE
173MFTN	MFTN	10,12	1 PIECE	NATURAL GAS/PROPANE

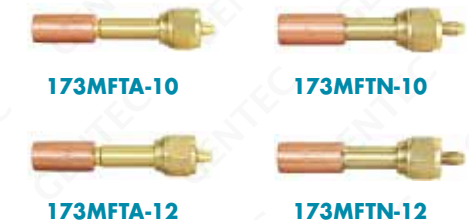

Victor® is a registered trademark of Victor Equipment Co., which is not associated with Genstar Technologies Co., Inc.

HARRIS® Style Cutting Tips

Tip Series	Harris® Equivalent	Sizes Available	Type	Gases
472C	6290	000-6	1 PIECE	ACETYLENE
472CN	6290NX	000-6	2 PIECE	NATURAL GAS/PROPANE



472C



472CN

HARRIS® Machine Torch High Speed Cutting Tips

Tip Series	Harris® Equivalent	Sizes Available	Type	Gases
473CHN	6290-VVC	0-8	2 PIECE	NATURAL GAS/PROPANE



473CHN

CONCOA®/AIRCO® Style Cutting Tips

Tip Series	Concoa®/Airco® Equivalent	Sizes Available	Type	Gases
672C	144	0-2	1 PIECE	ACETYLENE
673C	164	0-2	1 PIECE	ACETYLENE



672C



673C

KOIKE/AIRCO® Style Machine Torch High Speed Cutting Tips

Tip Series	Koike®/Airco® Equivalent	Sizes Available	Type	Gases
672CHN	107D7	0-8	2 PIECE	NATURAL GAS
673CHNP	106D7	0-8	2 PIECE	PROPANE / PROPYLENE



672CHN



673CHNP



SMITH® Style Cutting Tips

Tip Series	Smith® Equivalent	Sizes Available	Type	Gases
572C	MC12	0-3	1 PIECE	ACETYLENE
572CN	MC40	1, 2	2 PIECE	NATURAL GAS/PROPANE
573C*	SC12	1, 2	1 PIECE	ACETYLENE

* 573C Series can also be used on machine torch



572C



573C

Tip Series	ESAB/Purox® Equivalent	Sizes Available	Type	Gases
772C	4202/16K	3, 4, 5	1 PIECE	ACETYLENE



772C

Harris® is a registered trademark of The Lincoln Electric Co., Airco® is a registered trademark of BOC Group, Inc., PUROX® & ESAB® are registered trademarks of ESAB® Welding & Cutting Products. Smith® Equipment is a registered trademark of Smith Equipment Manufacturing Co., Concoa® is a registered trademark of Controls Corps. of America. These companies are not associated with Genstar Technologies Co., Inc.

Craft • Hobby • Jewelry

GENTEC® lightweight And Durable Oxy-fuel Small Torch provides precision flame adjustment and control for soldering and brazing jobs on small parts or in very tight spaces. The small-size, chrome-plated brass torch handle, with stainless steel internal tubing and the small copper tips, provides the durability one needs. The 1/8" I.D. strong and flexible color-coded (green for oxygen and red for fuel gas) twin hoses are easy to maneuver. The Small Torch is perfect for hobby, craft, glass blowing, electronic repair and manufacturing. It is also good for light duty metal sculpture and HVAC/R repair.

- The Small Torch Kit is available with theft deterrent point-of-purchase display packaging
- Lightweight durable construction with chrome-plated solid brass body and stainless steel inner gas tubes
- Easy manipulation in very tight spaces
- Designed to braze and solder the smallest of materials
- Can melt up to 3 oz of silver and weld up to 5/32" thick steel
- Oxy-Acetylene and Oxy-Fuel Kits
- Provides a stable and precise concentrated feather flame up to 6000° F
- Oxy-Fuel Kit (KSTP14-TSP) is available for use with disposable oxygen and 1 lb Propane / MAPP gas cylinders
- Durable and Flexible hoses with "B" connections ("A" connection adapters are available)
- SMITH EQUIPMENT® The Little Torch compatible

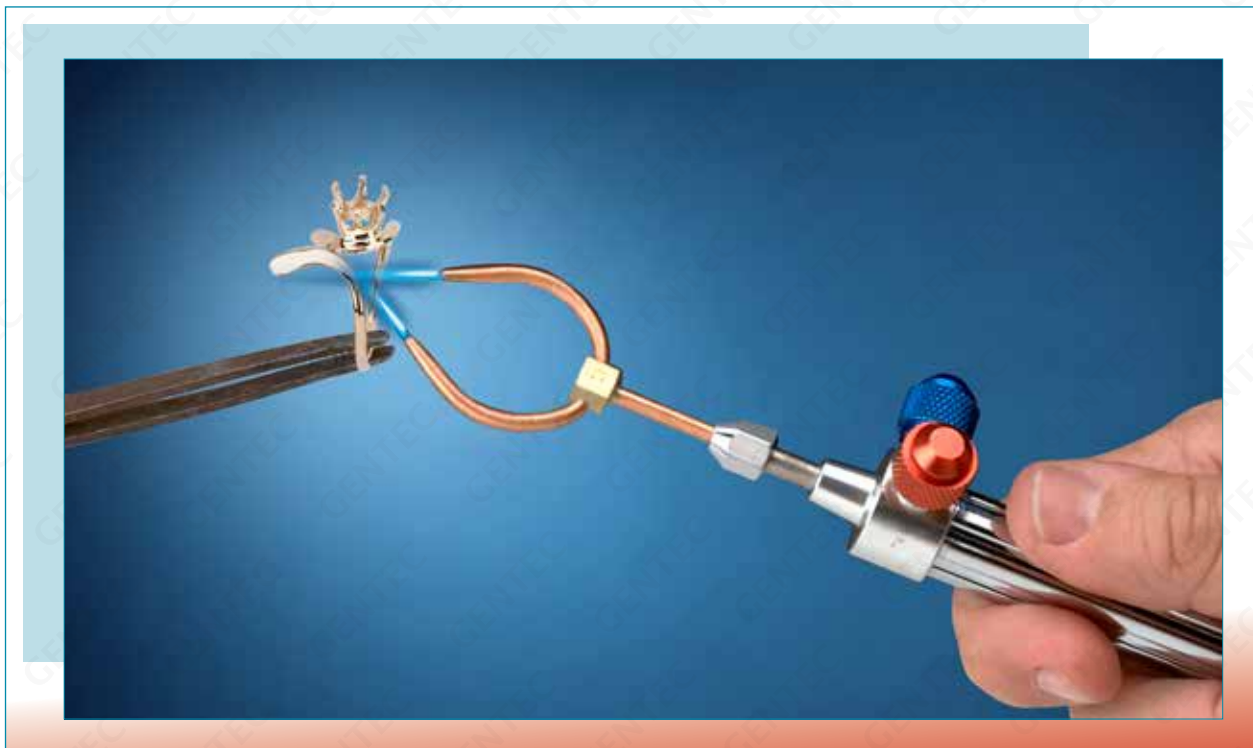

SMITH EQUIPMENT® and The Little Torch™ are registered trademarks of Illinois Tool Works Inc. which is not associated with Genstar Technologies Co., Inc.

Oxy-Acetylene & Oxy-Fuel Anti-Theft Packaging Kits with Cylinders



KSTA16TC-H12SP

* Kits include MC Tank Wrench: 27-0005
 ** Check Valve model number: 24-CV9PR (pair)
 *** Use with Disposable Cylinders

Model Number	Gas Service	Torch Handle	Tips	Hoses	Oxygen Regulator	Fuel Regulator	Cylinder Stand	Cylinder Oxygen / Fuel	Check Valve
KSTA16-TCSP*	ACETYLENE	10ST	10STP-3~7	HST18-6 w/Check Valves**	710X-80	710Y-15	CRT10	CY20-540 / CY10-MC	24-CV9PR
KSTA16TC-H12SP*	ACETYLENE	10ST	10STP-3~7	HST18-12 w/Check Valves**	710X-80	710Y-15	CRT10		
KSTP16TC-H12SP*	PROPANE	10ST	10STP-3~7	HST18-12 w/24-CV9RO Check Valve	710X-80	GRST-LP***	CRT10	CY20-540 / N/A	24-CV9RO

Oxy-Acetylene & Oxy-Fuel Kits



KSTP14-TSP



KSTA06-H12SP



KSTA16-H12SP

Model Number	Gas Service	Torch Handle	Tips	Hoses	Oxygen Regulator	Fuel Regulator	Cylinder Stand	B to A Hose Adapters	Check Valves
KSTA04SP	ACET./PROP./MAPP®	10ST	10STP-4	HST18-06	N/A	N/A	N/A	24-0105/24-0106	N/A
KSTA06SP	ACETYLENE	10ST	10STP-2~6	HST18-06	N/A	N/A	N/A	24-0105/24-0106	N/A
KSTA06-H12SP	ACETYLENE	10ST	10STP-2~6	HST18-12	N/A	N/A	N/A	24-0105/24-0106	N/A
KSTP06-H12SP	ACET./PROP./MAPP®	10ST	10STP-3~7	HST18-12	N/A	N/A	N/A	24-0105/24-0106	N/A
KSTP14-TSP	PROPANE/MAPP®	10ST	10STP-4	HST18-06	GRST-X**	GRST-LP**	CRTST	N/A	N/A
KSTA16SP	ACETYLENE	10ST	10STP-2~6	HST18-06	710X-80	710Y-15	N/A	N/A	24-CV9PR
KSTA16-BSP	ACETYLENE	10ST	10STP-2~6	HST18-06	710X-80	710Y-15-5	N/A	N/A	24-CV9PR
KSTA16-H12SP	ACETYLENE	10ST	10STP-2~6	HST18-12	710X-80	710Y-15	N/A	N/A	24-CV9PR
KSTA16B-H12SP	ACETYLENE	10ST	10STP-2~6	HST18-12	710X-80	710Y-15-5	N/A	N/A	24-CV9PR
KSTP16SP	PROPANE/MAPP®	10ST	10STP-3~7	HST18-06	710X-80	710F-80	N/A	N/A	24-CV9PR
KSTP16-H12SP	PROPANE/MAPP®	10ST	10STP-3~7	HST18-12	710X-80	710F-80	N/A	N/A	24-CV9PR

**Use with Disposable Cylinders

MAPP® is a registered trademark of BOC Group, Inc., which is not associated with Genstar Technologies Co., Inc.

Compressed Gas Regulators

To order skin package, add "SP" after the model number Example: GRST-XSP

Model Number	Gas Service	Inlet Connection	Outlet Connection
GRST-X*	OXYGEN	CGA 601	9/16"-18RH(M)
GRST-LP*	PROPANE/MAPP®	CGA 600	9/16"-18LH(M)
710X-80	OXYGEN	CGA 540 REAR	9/16"-18RH(M)
710X-80-A	OXYGEN	CGA 540 REAR	3/8"-18RH(M)
710Y-15-5	ACETYLENE	CGA 520 REAR	9/16"-18LH(M)
710Y-15	ACETYLENE	CGA 200 "MC" REAR	9/16"-18LH(M)
710F-80	PROPANE/MAPP®	CGA 510 REAR	9/16"-18LH(M)

*Use with Disposable Cylinders

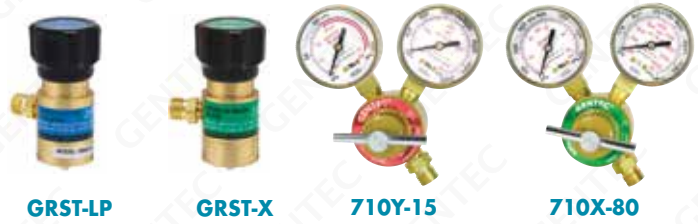

Replacement Hoses (Include Ferrules)

Model Number	Gas Service	Dimension	Connection
HST18-06	OXY/FUEL(TWIN)	1/8"x6'	9/16"-18RH/LH(F)
HST18-12	OXY/FUEL(TWIN)	1/8"x12'	9/16"-18RH/LH(F)



HST18-06

Small Torch Stand



CRTST

Oxy-Acetylene / Oxy-Fuel Torch Handle - 11ST & 10ST Series

Model Number	Gas Service	Torch Handle & Hose
11ST	OXY-ACET./FUEL	TORCH HANDLE ONLY (STAR KNOB)
10ST	OXY-ACET./FUEL	TORCH HANDLE ONLY
10ST-H06	OXY-ACET./FUEL	TORCH HANDLE w/6' HOSE
10ST-H12	OXY-ACET./FUEL	TORCH HANDLE w/12' HOSE



11ST

10ST

10ST with Hose

Oxy-Acetylene / Oxy-Fuel Tips

▣ CURVED TIPS

#2 and #3 Tips fitted with synthetic sapphire to assure superior flame control



10STP

▣ CURVED TIPS COMBO PACK (SKIN PACKAGE)

▣ TWIN TIPS



10STP-3C

Model Number	Size	Gas Service
10STP-2	#2	OXY-ACETYLENE
10STP-3	#3	OXY-ACETYLENE/PROPANE/MAPP®
10STP-4	#4	OXY-ACETYLENE/PROPANE/MAPP®
10STP-5	#5	OXY-ACETYLENE/PROPANE/MAPP®
10STP-6	#6	OXY-ACETYLENE/PROPANE/MAPP®
10STP-7	#7	OXY-ACETYLENE/PROPANE/MAPP®

Model Number	Size
K10STP06SP	2, 3, 4, 5, 6
K10STP07SP	3, 4, 5, 6, 7

Model Number	Size	Gas Service
10STP-3C	3	OXY-ACETYLENE/PROPANE/MAPP®
10STP-4C	4	OXY-ACETYLENE/PROPANE/MAPP®
10STP-5C	5	OXY-ACETYLENE/PROPANE/MAPP®

10STP-7	
10STP-6	
10STP-5	
10STP-4	
10STP-3	
10STP-2	
Approx. Feather Flame Characteristics	

Multi-Flame Rosebud Heating Tips

Model Number	Length	Gas Service
10STP-HF6	6"	OXY-PROPANE/MAPP®
10STP-HY6	6"	OXY-ACETYLENE



10STP-HY6

10STP-HF6

HVAC & Plumbing

GENTEC® COMPACT TORCH gets you into tight spaces and allows you to do more precise work than any other torch on the market! The Compact Torch's small size, chrome-plated brass torch handle with stainless steel internal tubing and copper tips provides the durability one needs. The easily maneuverable 12-foot extra flexible twin hoses have "B" fittings for larger regulator connections. The Compact Torch is perfect for soldering and brazing jobs in HVAC & Plumbing industries. "A" fitting adaptors for light/medium duty regulators are included with Kits without regulators. Optional torch tips can be used for Oxy-Acetylene, Oxy-Propane or Oxy-MAPP gases.

- Lightweight durable construction with chrome-plated brass body and stainless steel inner gas tubes
- Easy manipulation in tight spaces
- Tips have double o-ring seats to ensure leak-proof connections
- Designed to braze and solder the smallest jobs up to 1-1/4" copper tubing
- Oxy-Acetylene and Oxy-Fuel Kits
- Durable and extra flexible hoses with "B" connections ("A" adaptors included in Kits without regulators)

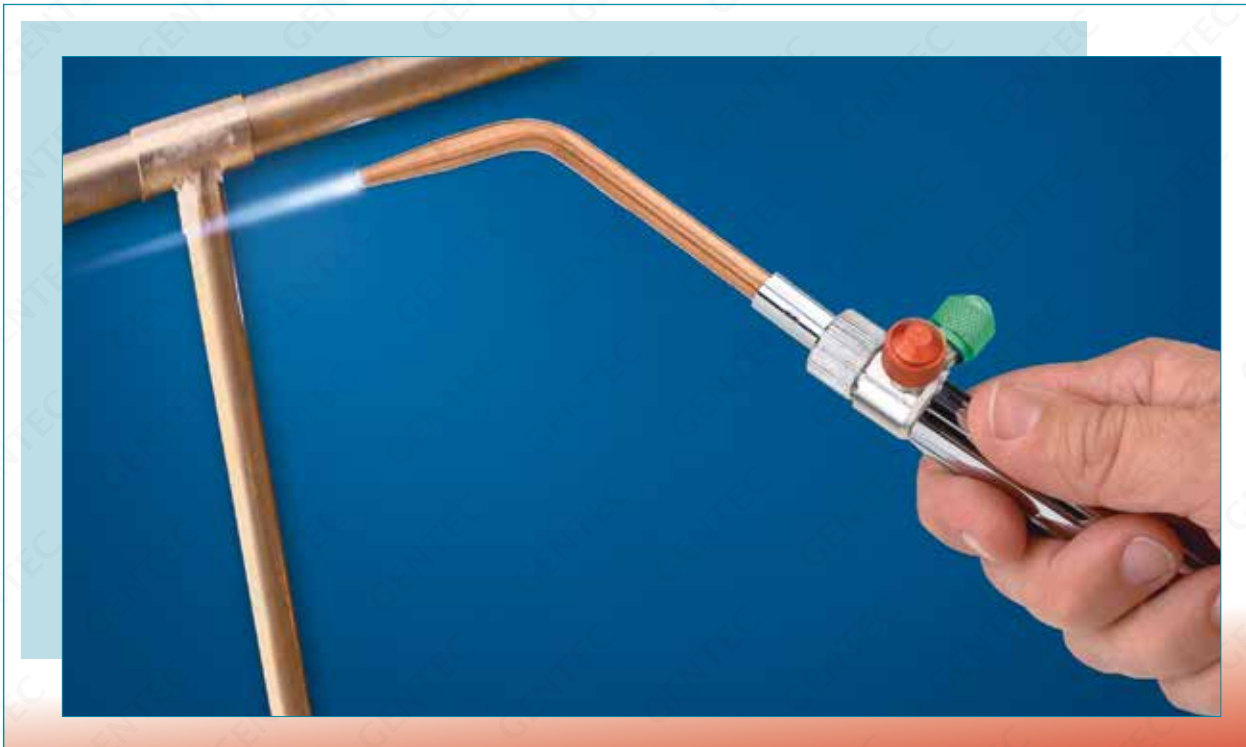

Oxy-Acetylene Anti-Theft Packaging Kit with Cylinders

Model Number	KCMA16TCSP
GAS SERVICE:	OXY-ACETYLENE
TORCH HANDLE:	10CM
TIPS:	10CMP-GMTT 10CMP-GMTR 10CMP-4 10CMP-6
TWIN HOSES:	HST18-12 (12')
OXYGEN REGULATOR*:	710X-80G
ACETYLENE REGULATOR*:	710Y-15G
OXYGEN CYLINDER:	CY20-540
ACETYLENE CYLINDER:	CY10-MC
TANK WRENCH:	27-0005
CYLINDER CARRIER:	CRT10
CHECK VALVES:	24-CV9PR

*This regulator comes with gauge guards



KCMA16TCSP

Oxy-Acetylene & Oxy-Fuel Kits



KCMA16SP



KCMA26SP



KCMA04SP

Model Number	Gas Service	Torch Handle	Tips	Hose	Oxygen Regulator	Fuel Regulator	B to A Hose Adapters	Check Valves
KCMA04SP	ACET./PROP./MAPP®	10CM	10CMP-4	HST18-12	N/A	N/A	24-0105/24-0106	N/A
KCMA26SP	ACET./PROP./MAPP®	10CM	10CMP-GMTT, 10CMP-GMTR, 10CMP-4, 10CMP-6	HST18-12	N/A	N/A	24-0105/24-0106	N/A
KCMA16-BSP	ACETYLENE	10CM	10CMP-4	HST18-12	710X-80	710Y-15-5	N/A	24-CV9PR
KCMA16SP	ACETYLENE	10CM	10CMP-GMTT, 10CMP-GMTR, 10CMP-4, 10CMP-6	HST18-12	710X-80	710Y-15	N/A	24-CV9PR
KCMP16SP	PROPANE/MAPP®	10CM	10CMP-GMTT, 10CMP-GMTR, 10CMP-3, 10CMP-7	HST18-12	710X-80	710F-80	N/A	24-CV9PR

MAPP® is a registered trademark of BOC Group, Inc., which is not associated with Genstar Technologies Co., Inc.

Compressed Gas Regulators

Model Number	Gas Service	Inlet Connection	Outlet Connection
710X-80	OXYGEN	CGA540 REAR	9/16"-18RH(M)
710X-80G			
710Y-15-5	ACETYLENE	CGA520 REAR	9/16"-18LH(M)
710Y-15			
710Y-15G	ACETYLENE	CGA200 "MC" REAR	9/16"-18LH(M)
710F-80			



710Y-15



710X-80



710Y-15G



710X-80G

Replacement Twin Hoses (Includes Hose Clamps*)

Model Number	Gas Service	Dimension	Connection
HST18-12	OXY/FUEL(TWIN)	1/8"x12'	9/16"-18RH/LH(M)

*Hose clamps model No. 007-505R



HST18-12

Oxy-Acetylene/Oxy-Fuel Torch Handle - 10CM Series

Model Number	Gas Service	Description
10CM	OXY-ACET./FUEL	TORCH HANDLE ONLY
10CM-H12	OXY-ACET./FUEL	TORCH HANDLE w/12' HOSE



10CM-H12



10CM

Torch Handle Components - Torch Valve Stems

Model Number	Description
T10-82B	GREEN VALVE (OXYGEN)
T10-83B	RED VALVE (FUEL)

Oxy-Acetylene/Oxy-Fuel Tips

Model Number	Size	Gas Service
10CMP-2	2	OXY-ACETYLENE
10CMP-3	3	OXY-ACETYLENE/PROPANE/MAPP®
10CMP-4	4	OXY-ACETYLENE/PROPANE/MAPP®
10CMP-5	5	OXY-ACETYLENE/PROPANE/MAPP®
10CMP-6	6	OXY-ACETYLENE/PROPANE/MAPP®
10CMP-7	7	OXY-ACETYLENE/PROPANE/MAPP®
171W-000	000	OXY-ACETYLENE
171W-00	00	OXY-ACETYLENE
171W-0	0	OXY-ACETYLENE



10CMP



171W

Brazing Tip Comparison Chart

Model Number	Brazing Tip Capacity For Copper	W-J Comparison
10CMP-2	1/8"-1/4" (3-6mm)	N/A
10CMP-3	1/8" - 1/2" (3-12mm)	000
10CMP-4	1/8" - 3/4" (3-19mm)	00
10CMP-5	1/4" - 7/8" (6-23mm)	0
10CMP-6	1/4" - 1" (6-26mm)	1
10CMP-7	3/8" - 1 1/8" (10-29mm)	2
10CMP-GMIT	1/4" - 1" (6-26mm)	N/A
10CMP-GMTR	3/8" - 1 1/4" (10-32mm)	N/A



Multi-Flame Rosebud Heating Tip

Model Number	Gas Service
10CMP-GMTR	ACET./PROP./MAPP®



10CMP-GMTR

Twin Tip

Model Number	Gas Service
10CMP-GMIT	OXY-ACET./PROPANE/MAPP®



10CMP-GMIT

Tip Combo Pack (Skin Package)

Model Number	Tips	Gas Service
10CMP-C3SP	10CMP-GMIT (Twin Tip)	OXY-ACET./PROP./MAPP®
	10CMP-GMTR (Multi-Flame)	
	10CMP-3 (Curved Tip #3)	
	10 CMP-7 (Curved Tip #7)	
10CMP-C4SP	10CMP-GMIT (Twin Tip)	
	10CMP-GMTR (Multi-Flame)	
	10CMP-4 (Curved Tip #4)	
	10 CMP-6 (Curved Tip #6)	

Replacement O-Rings for 10CMP

Model Number	Description
T110-26	LARGE O-RING
T110-27	SMALL O-RING

MAPP® is a registered trademark of BOC Group, Inc., which is not associated with Genstar Technologies Co., Inc.

WBK-500 MUL-T-TORCH[†] Air Propane Torch Outfit



- Designed for heavy-duty outdoor applications
- Large volume of heat (up to 500,000 BTUs) for weed burning, ice melting, asphalt removal, and many other applications
- For use with standard 20lb bar-b-que and larger liquid propane tanks
- All steel torch handle and torch head
- Excess flow safety valve shuts off flow when hose is accidentally cut or melted
- 10' durable hose and single-flint striker are included in the outfit
- Brass control knob will not freeze up in cold weather
- For use with propane only

KIT COMPONENTS

Model Number	Description
WB-500T	500,000 BTU REPLACEMENT TORCH WITH BRASS VALVE
HWB-10CV	10' REPLACEMENT HOSE WITH 24-CVWB CHECK VALVE
24-CVWB	EXCESS FLOW SAFETY VALVE WITH P.O.L. CONNECTION

COMPRESSED GAS REGULATORS

Compressed Gas Regulator Overview

Industrial Gas Apparatus

Compressed Gas Regulators

GENTEC® Compressed gas regulators are manufactured using state-of-the-art equipment. They are produced, assembled, and tested by an experienced, proud, and dedicated work force that is committed to the highest standards of product integrity. They are suitable for a variety of gas pressure reduction and control requirements such as welding, cutting, heating, and brazing.

GENTEC® flow gauge and flowmeter regulators provide accurate regulation and measurement of gas flow for use in commercial, industrial, welding, and laboratory applications. Models are available with preset and adjustable flow rates.

PRODUCT CATEGORY

- Cylinder Regulators
- Liquid Cylinder Regulators
- Station Regulators
- Pipeline Regulators
- Manifold Regulators
- Flow Gauge Regulators
- Compact Pre-Set Gas Regulators
- Gas Saving Flowmeter Regulators
- Flowmeter Regulators
- Balloon Filler Regulators



- AIR
- OXYGEN
- ACETYLENE
- METHANE
- PROPANE
- HYDROGEN
- BUTANE
- NITROGEN
- ARGON
- CO2
- HELIUM
- OTHER GASES

591 Series High Pressure Piston Regulators

Model 591 Series High Pressure Piston Regulators feature a reliable piston design for precise gas control at high inlet and delivery pressures rating up to 4500 PSIG. Like all GENTEC® quality products, the 591 Series provides superior performance and safety features.

- Piston-type construction
- Body and housing cap are machined from class “A” brass
- Delrin cap bushing for smooth adjustments
- Sintered bronze inlet filter
- 1/4” Stainless steel Compression-Tube Fitting (GENLOK™) Outlet
- 2-1/2” gauges
- Weight: 4 lbs
- Conforms to CGA E-4 standard for
- gas pressure regulators



591

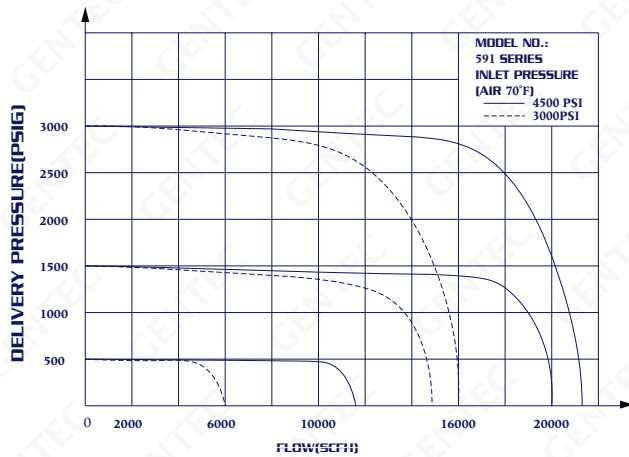

Model Number	Gas Service	Maximum Inlet Pressure (PSI)	Maximum Delivery Pressure (PSI)	Inlet Gauge	Outlet Gauge	Inlet Connection	Outlet Connection
591X-750	OXYGEN	3000	50 - 750	2-1/2", 4000PSI	2-1/2", 1000PSI	CGA540	1/4" SS COMP. TUBE FITTING
591X-1500			100 - 1500		2-1/2", 2000PSI		
591X-3000			200 - 3000		2-1/2", 4000PSI		
591IN-750	INERT GAS (Ar, He, N ₂)	3000	50 - 750	2-1/2", 4000PSI	2-1/2", 1000PSI	CGA580	1/4" SS COMP. TUBE FITTING
591IN-1500			100 - 1500		2-1/2", 2000PSI		
591IN-3000			200 - 3000		2-1/2", 4000PSI		
591IN-1500-680	INERT GAS (Ar, He, N ₂)	5500	100 - 1500	2-1/2", 6000PSI	2-1/2", 2000PSI	CGA680	1/4" SS COMP. TUBE FITTING
591IN-3000-680			200 - 3000		2-1/2", 4000PSI		
591IN-4500-680			300 - 4500		2-1/2", 6000PSI		
591Q-1500	AIR	3000	100 - 1500	2-1/2", 4000PSI	2-1/2", 2000PSI	CGA346	1/4" SS COMP. TUBE FITTING
591Q-3000			200 - 3000		2-1/2", 4000PSI		
591Q-1500-347	AIR	5500	100 - 1500	2-1/2", 6000PSI	2-1/2", 2000PSI	CGA347	1/4" SS COMP. TUBE FITTING
591Q-3000-347			200 - 3000		2-1/2", 4000PSI		
591Q-4500-347			300 - 4500		2-1/2", 6000PSI		
591H-750	HYDROGEN METHANE	3000	50 - 750	2-1/2", 4000PSI	2-1/2", 1000PSI	CGA350	1/4" SS COMP. TUBE FITTING
591H-1500			100 - 1500		2-1/2", 2000PSI		
591H-3000			200 - 3000		2-1/2", 4000PSI		

1 psi = 0.00689 MPa = 6.895 kPa = 0.06895 bar = 0.07 kgf / cm², 1 scfh = 0.0283 m³/h = 0.472 LPM

190 SERIES

Light Duty Single Stage Regulators

Industrial Gas Apparatus

190 Series Regulators

With a lightweight, compact, and single-stage design, they are ideal for light to medium duty gas welding, cutting, and heating applications.

- Body is machined from class "A" brass
- Chrome-plated housing cap
- Internal pressure relief valve
- Sintered bronze inlet filter
- Stem-type seat assembly for more reliable seating
- 2" gauges for easy reading
- 1-1/4" diaphragm
- Weight: 2 lbs 1 oz
- UL listed



190

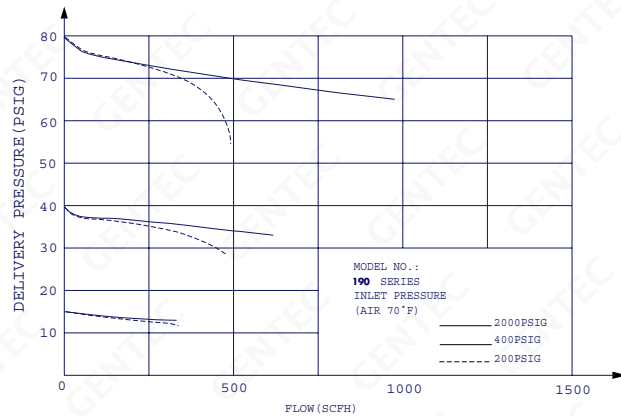

Model Number	Gas Service	Maximum Inlet Pressure (PSI)	Maximum Delivery Pressure (PSI)	Inlet Gauge	Outlet Gauge	Inlet Connection	Outlet Connection
190F-80	L.P. GAS	400	4-80	2", 400PSI	2", 100PSI	CGA510	9/16" - 18LH(M)
190X-80	OXYGEN	3000	4-80	2", 4000PSI	2", 100PSI	CGA540	9/16" - 18RH(M)
190Y-15	ACETYLENE	400	2-15	2", 4000PSI	2", 30PSI, RL	CGA510	9/16" - 18LH(M)
190Y-15-3						CGA300	
190Y-15-5						CGA520	
190IN-80	INERT GAS (Ar, He, N ₂)	3000	4-80	2", 4000PSI	2", 100PSI	CGA580	5/8" - 18RH(F)
190IN-175			5-175	2", 4000PSI	2", 300PSI		5/8" - 18RH(F)
190IN-175-F			5-175	2", 4000PSI	2", 300PSI		1/4" SAE FLARE
190C-175	CARBON DIOXIDE	3000	5-175	2", 4000PSI	2", 300PSI	CGA320	5/8" - 18RH(F)
190C-175-F							1/4" SAE FLARE
190H-80	HYDROGEN METHANE	3000	4-80	2", 4000PSI	2", 100PSI	CGA350	9/16" - 18LH(M)

1 psi = 0.00689 MPa = 6.895 kPa = 0.06895 bar = 0.07 kgf / cm², 1 scfh = 0.0283 m³/h = 0.472 LPM

210 & 210Y1 Series Regulators

Featuring a compact rear entry design to meet the demands of special installation, these regulators are best for light to medium duty gas welding, cutting and heating applications, such as industrial maintenance, farm and shop repair, hobby, crafts and home care.

- Rear entry inlet construction
- Body is machined from class "A" brass
- Chrome-plated housing cap
- Internal pressure relief valve
- Sintered bronze inlet filter
- Stem-type seat assembly for more reliable seating
- Plastic adjustment knob for smooth "easy touch" pressure setting
- 2" gauges for easy reading. 210 Series has two gauges and 210Y1 Series has one gauge (inlet gauge) only
- 1-1/4" diaphragm
- Rubber gauge protectors are color coded: green for Oxygen (GP20X) and red for Acetylene (GP20Y)
- Weight: 210 Series: 2 lbs 3 oz
- 210Y1 Series: 1 lb 14 oz
- UL Listed



210



210Y1

Gauge Guard Models



210X-80



210Y-15G

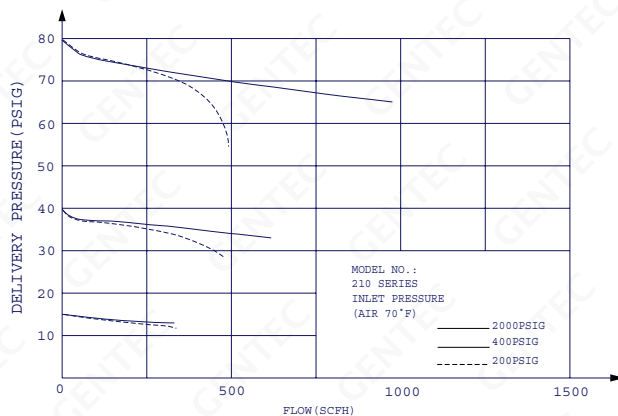

Model Number	Gas Service	Maximum Inlet Pressure (PSI)	Maximum Delivery Pressure (PSI)	Inlet Gauge	Outlet Gauge	Inlet Connection	Outlet Connection
210F-80	PROPANE	400	4-80	2", 400PSI	2", 100PSI	CGA510 REAR	9/16" - 18LH(M)
210X-80	OXYGEN	3000	4-80	2", 4000PSI	2", 100PSI	CGA540 REAR	9/16" - 18RH(M)
210X-80-A							3/8" - 24RH(M)
210Y-15	ACETYLENE	400	2-15	2", 400PSI	2", 30PSI, RL	CGA200 "MC" REAR	9/16" - 18LH(M)
210Y-15-5							9/16" - 18LH(M)
210Y-15-A							3/8" - 24LH(M)
210Y-15-510							9/16" - 18LH(M)
210Y-15-510-A							3/8" - 24LH(M)
210Y-15-3							9/16" - 18LH(M)
210Y-15-3-A							3/8" - 24LH(M)
210Y1-15-B							ACETYLENE
210Y1-15-M	3/8" - 24LH(M)						

1 psi = 0.00689 MPa = 6.895 kPa = 0.06895 bar = 0.07 kgf / cm², 1 scfh = 0.0283 m³/h = 0.472 LPM

152 Series Regulators

Designed for medium duty gas welding, cutting, and heating applications. These regulators are ideal for industrial applications, farm repairs and laboratory testing, etc.

- Forged brass body and housing cap
- Delrin cap bushing for smooth adjustments
- Self re-seating external pressure relief valve on oxygen, inert gas, and air models
- Sintered bronze inlet filter
- Stem-type seat assembly for more reliable performance
- 2" gauges for easy reading
- 2" diaphragm
- Steel Gauge Protectors are color coded: green for Oxygen (GP21X) and red for Acetylene (GP21Y)
- Weight: 2 lbs 11 oz
- UL Listed



152

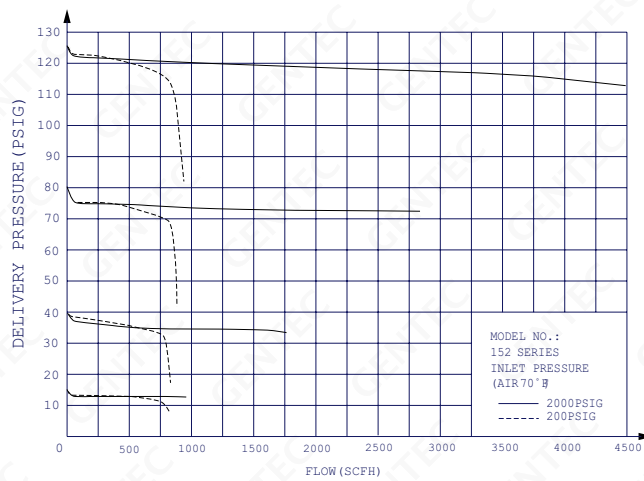

Gauge Guard Models



152X-80G
152X-125G



152Y-15G
152Y-15-3G
152Y-15-5G

Model Number	Gas Service	Maximum Inlet Pressure (PSI)	Maximum Delivery Pressure (PSI)	Inlet Gauge	Outlet Gauge	Inlet Connection	Outlet Connection
152F-80	L.P. GAS	400	4-80	2", 400PSI	2", 100PSI	CGA510	9/16" - 18LH(M)
152X-80	OXYGEN	3000	4-80	2", 4000PSI	2", 100PSI	CGA540	9/16" - 18RH(M)
152X-125	OXYGEN	3000	5-125	2", 4000PSI	2", 200PSI	CGA350	9/16" - 18RH(M)
152Y-15	ACETYLENE	400	2-15	2", 400PSI	2", 30PSI, RL	CGA510	9/16" - 18LH(M)
152Y-15-3						CGA300	
152Y-15-5						CGA520	
152IN-15	INERT GAS (Ar, He, N ₂)	3000	2-15	2", 4000PSI	2", 30PSI	CGA580	5/8"-18RH(F)
152IN-125	INERT GAS (Ar, He, N ₂)	3000	5-125	2", 4000PSI	2", 200PSI	CGA580	5/8"-18RH(F)
152Q-15	AIR	3000	2-15	2", 4000PSI	2", 30PSI	CGA346	5/8"-18RH(M)
152Q-125			5-125		2", 200PSI		
152H-15	HYDROGEN METHANE	3000	2-15	2", 4000PSI	2", 30PSI	CGA350	9/16" - 18LH(M)
152H-40			2-40	2", 4000PSI	2", 60PSI	CGA350	9/16" - 18LH(M)
152H-125			5-125	2", 4000PSI	2", 200PSI	CGA350	9/16" - 18LH(M)

1 psi = 0.00689 MPa = 6.895 kPa = 0.06895 bar = 0.07 kgf / cm², 1 scfh = 0.0283 m³/h = 0.472 LPM

452 Series Regulators

Designed for medium to heavy duty gas welding, cutting, and heating applications, 452 Series is a Harris® style regulator with a 2-3/4" diaphragm and a Victor® style seat mechanism.

- 2" gauges for easy reading
- Stem-type seat assembly for more reliable performance
- Forged brass body
- Chrome-plated housing cap for fuel gas and oxygen models
- Self re-seating external pressure relief valve on oxygen, inert gas, CO2 and nitrogen models
- Sintered bronze inlet filter
- Weight: 3 lbs
- UL listed

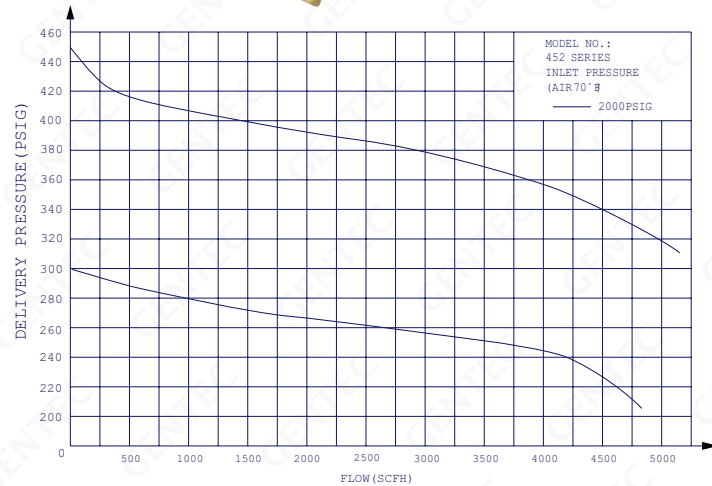

Model Number	Gas Service	Maximum Inlet Pressure (PSI)	Maximum Delivery Pressure (PSI)	Inlet Gauge	Outlet Gauge	Inlet Connection	Outlet Connection
452F-40	L.P. GAS	400	2-40	2", 400PSI	2", 60PSI	CGA510	9/16" - 18LH(M)
452F-125			5-125		2", 200PSI		
452X-80	OXYGEN	3000	4-80	2", 4000PSI	2", 100PSI	CGA540	9/16" - 18RH(M)
452X-175			5-175		2", 300PSI		
452Y-15	ACETYLENE	400	2-15	2", 400PSI	2", 30PSI, RL	CGA510	9/16" - 18LH(M)
452Y-15-3					CGA300		
452Y-15-5					CGA520		
452C-175	CARBON DIOXIDE	3000	5-175	2", 4000PSI	2", 300PSI	CGA320	5/8" - 18RH(F)
452C-175-F			5-175		2", 300PSI		1/4" SAE FLARE
452C-300			20-300		2", 400PSI		5/8" - 18RH(F)
452C-300-F			20-300		2", 400PSI		1/4" SAE FLARE
452IN-80	INERT GASES (Ar, He) NITROGEN	3000	4-80	2", 4000PSI	2", 100PSI	CGA580	5/8" - 18RH(F)
452IN-175			5-175		2", 300PSI		5/8" - 18RH(F)
452IN-175-F			5-175		2", 300PSI		1/4" SAE FLARE
452IN-300			20-300		2", 400PSI		5/8" - 18RH(F)
452IN-300-F			20-300		2", 400PSI		1/4" SAE FLARE
452IN-450			30-450		2", 600PSI		5/8" - 18RH(F)
452IN-450-F			30-450		2", 600PSI		1/4" SAE FLARE
452IN-175-F-680			INERT GASES (Ar, He) NITROGEN		5500		5-175
452IN-450-F-680	30-450	2", 600PSI					

1 psi = 0.00689 MPa = 6.895 kPa = 0.06895 bar = 0.07 kgf / cm², 1 scfh = 0.0283 m³/h = 0.472 LPM

Harris® is a registered trademark of The Lincoln Electric Co., Victor® is a registered trademark of Victor Equipment Co. These companies are not associated with Genstar Technologies Co., Inc.

453 SERIES

Medium to Heavy Duty Single Stage Regulators

Industrial Gas Apparatus

453 Series Single Stage Regulators

Designed for medium to heavy duty gas welding, cutting and heating applications, these single-stage regulators provide top performance in a wide variety of industrial and laboratory applications.

- Self re-seating external pressure relief valve on oxygen models
- Conforms to CGA E-4 standard for gas pressure regulators
- Stem-type seat assembly for more reliable performance
- Forged brass body
- 2-1/2" gauges for easy reading
- 2-3/4" diaphragm
- Weight: 3 lbs 8 oz



453

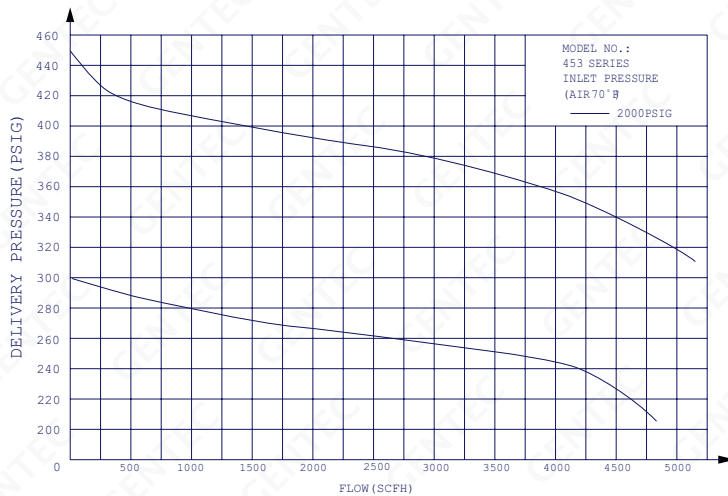

Model Number	Gas Service	Maximum Inlet Pressure (PSI)	Maximum Delivery Pressure (PSI)	Inlet Gauge	Outlet Gauge	Inlet Connection	Outlet Connection
453X-175	OXYGEN	3000	5-175	2-1/2", 4000PSI	2-1/2", 300PSI	CGA540	9-16" - 18RH(M)
453Y-15	ACETYLENE	400	2-15	2-1/2", 400PSI	2-1/2", 30PSI, RL	CGA510	9-16" - 18LH(M)
453Y-15-3						CGA300	

1 psi = 0.00689 MPa = 6.895 kPa = 0.06895 bar = 0.07 kgf / cm², 1 scfh = 0.0283 m³/h = 0.472 LPM

853 Series Single Stage Regulators

Designed for medium to heavy duty gas welding, cutting and heating applications, these single-stage regulators provide top performance in a wide variety of industrial and laboratory applications.

- Self re-seating external pressure relief valve on oxygen models
- Forged brass body and housing cap
- Conforms to CGA E-4 standard for gas pressure regulators
- Stem-type seat assembly for more reliable performance
- Delrin cap bushing for smooth adjustment
- 2-1/2" gauges for easy reading
- 2-3/4" diaphragm
- Weight: 3 lbs 8 oz



853

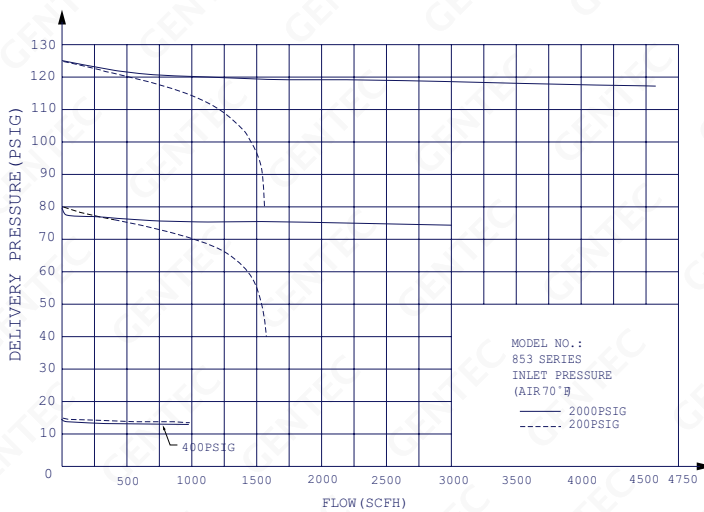

Model Number	Gas Service	Maximum Inlet Pressure (PSI)	Maximum Delivery Pressure (PSI)	Inlet Gauge	Outlet Gauge	Inlet Connection	Outlet Connection
853F-80	L.P. GAS	400	4-80	2-1/2", 400PSI	2-1/2", 100PSI	CGA510	9-16" - 18LH(M)
853X-125	OXYGEN	3000	5-125	2-1/2", 4000PSI	2-1/2", 200PSI	CGA540	9-16" - 18RH(M)
853Y-15	ACETYLENE	400	2-15	2-1/2", 400PSI	2-1/2", 30PSI, RL	CGA510	9-16" - 18LH(M)
853Y-15-3						CGA300	

1 psi = 0.00689 MPa = 6.895 kPa = 0.06895 bar = 0.07 kgf / cm2, 1 scfh = 0.0283 m3/h = 0.472 LPM

853LCR SERIES

Liquid Cylinder Regulators

Industrial Gas Apparatus

853LCR Series Single Stage Liquid Cylinder Regulators

853LCR Series Liquid Cylinder Regulators are specially designed for gaseous withdrawal from liquid cylinders of Oxygen, Carbon Dioxide and Nitrogen. Not for use on high pressure cylinders.

- Vapor side application on liquid cylinders or vessels
- 0-125 PSI delivery pressure
- 500 PSI maximum inlet pressure
- Large 2-3/4" stainless steel diaphragm
- 500 PSI external pressure relief valve on high pressure side
- Forged brass body and housing cap
- Delrin cap bushing for smooth pressure adjustment
- Stem-type seat assembly for more reliable performance
- Sintered bronze inlet filter
- 2-1/2" dual scale outlet gauge
- Conforms to CGA E-4 Standard for Gas Pressure Regulators



853LCR

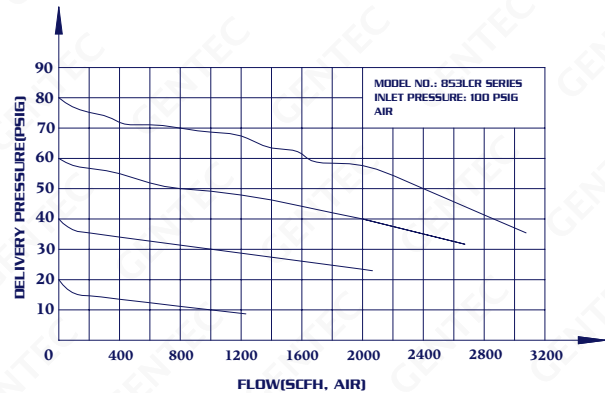
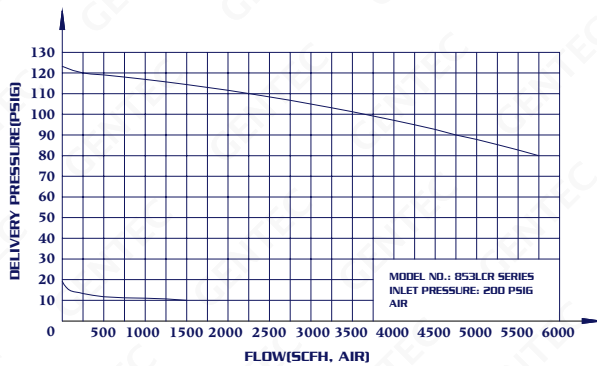

Model Number	Gas Service	Maximum Inlet Pressure (PSI)	Maximum Delivery Pressure (PSI)	Inlet Gauge	Outlet Gauge	Inlet Connection	Outlet Connection
853LCRX-125	OXYGEN	500	5-125	NONE	2-1/2", 200PSI	CGA540	9-16" - 18RH(M)
853LCRIN-125	NITROGEN	500	5-125	NONE	2-1/2", 200PSI	CGA580	5/8" - 18RH(F)
853LCRCD-125	CARBON DIOXIDE	500	5-125	NONE	2-1/2", 200PSI	CGA320	5/8" - 18RH(F)

1 psi = 0.00689 MPa = 6.895 kPa = 0.06895 bar = 0.07 kgf / cm², 1 scfh = 0.0283 m³/h = 0.472 LPM

153 Series Single Stage Regulators

Designed for heavy duty gas welding, cutting, and heating applications. These regulators are ideal to use for steel fabrication, ship building, metallurgical and chemical industries.

- 2-1/2" gauges for easy reading
- 3-1/4" stainless steel diaphragm for accurate pressure delivery
- Delrin cap bushing for smooth adjustments
- Stem-type seat assembly for more reliable performance
- Forged brass body and housing cap
- Self re-seating external pressure relief valve on oxygen, inert gas, air, CO₂, and hydrogen models
- Sintered bronze inlet filter
- Steel Gauge Protectors are color-coded: green for Oxygen (GP31X) and red for Acetylene (GP31Y) Models
- Weight: 4 lbs 13 oz
- UL listed

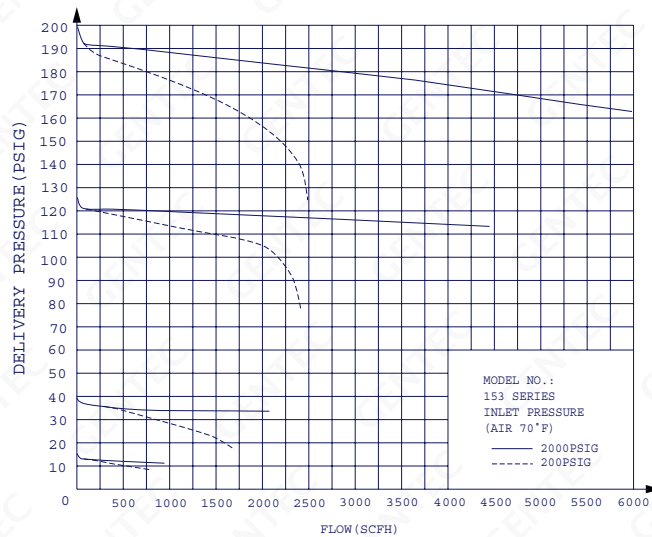

Gauge Guard Models



153X-125G



153Y-15G
153Y-15-3G

Model Number	Gas Service	Maximum Inlet Pressure (PSI)	Maximum Delivery Pressure (PSI)	Inlet Gauge	Outlet Gauge	Inlet Connection	Outlet Connection
153F-125	L.P. GAS	400	5-125	2-1/2", 400PSI	2-1/2", 200PSI	CGA510	9/16" - 18LH(M)
153X-125	OXYGEN	3000	5-125	2-1/2", 4000PSI	2-1/2", 200PSI	CGA540	9/16" - 18RH(M)
153X-250			10-250		2-1/2", 400PSI		
153Y-15	ACETYLENE	400	2-15	2-1/2", 400PSI	2-1/2", 30PSI, RL	CGA510 CGA300	9/16" - 18LH(M)
153Y-15-3					2-1/2", 400PSI		
153IN-125	INERT GAS (Ar, He, N ₂)	3000	5-125	2-1/2", 4000PSI	2-1/2", 200PSI	CGA580	5/8" - 18RH(F)
153IN-250			10-250		2-1/2", 400PSI		5/8" - 18RH(F)
153IN-250-F			10-250		2-1/2", 400PSI		1/4" SAE FLARE
153Q-125	AIR	3000	5-125	2-1/2", 4000PSI	2-1/2", 200PSI	CGA590	5/8" - 18RH(F)
153Q-200			10-200		2-1/2", 400PSI		9/16" - 18RH(M)
153C-125	CARBON DIOXIDE	3000	5-125	2-1/2", 4000PSI	2-1/2", 200PSI	CGA320	5/8" - 18RH(F)
153C-200			10-200		2-1/2", 400PSI		
153H-125	HYDROGEN METHANE	3000	5-125	2-1/2", 4000PSI	2-1/2", 200PSI	CGA350	9/16" - 18LH(M)
153H-200			10-200		2-1/2", 400PSI		

1 psi = 0.00689 MPa = 6.895 kPa = 0.06895 bar = 0.07 kgf / cm², 1 scfh = 0.0283 m³/hr = 0.472 LPM

155 SERIES

Extra Heavy Duty Single Stage Regulators

Industrial Gas Apparatus

155 Series Single Stage Regulators

These extra heavy duty models are designed for heavy duty cutting, industrial applications, laboratory testing, manifold installations, etc.

- Single-stage construction
- Forged brass body and housing cap
- Delrin cap bushing for smooth adjustments
- Self re-seating external pressure relief valve on oxygen, inert gas, air, and hydrogen models
- Sintered bronze inlet filter
- 2-1/2" gauges for easy reading
- 3-1/4" diaphragm
- Weight: 7 lbs 10 oz
- Conforms to CGA E-4 standard for gas pressure regulators



155

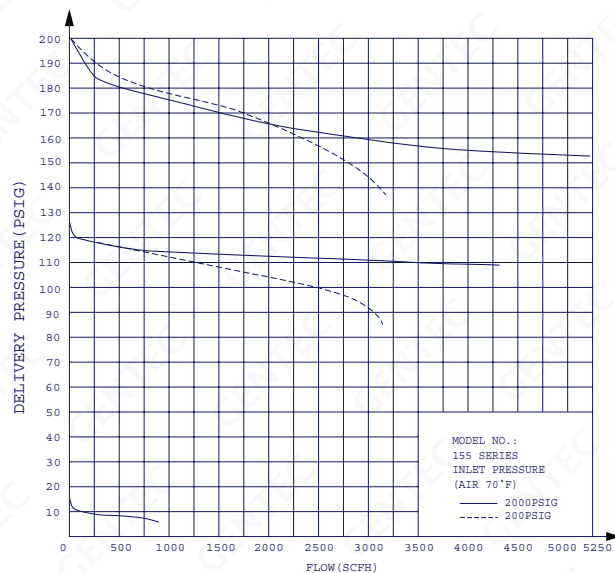

Model Number	Gas Service	Maximum Inlet Pressure (PSI)	Maximum Delivery Pressure (PSI)	Inlet Gauge	Outlet Gauge	Inlet Connection	Outlet Connection
155F-125	L.P. GAS	400	5-125	2-1/2", 400PSI	2-1/2", 200PSI	CGA510	7/8" - 14LH(M)
155X-125	OXYGEN	3000	5-125	2-1/2", 4000PSI	2-1/2", 200PSI	CGA540	7/8" - 14RH(M)
155X-200			10-200		2-1/2", 400PSI		
155Y-15	ACETYLENE	400	2-15	2-1/2", 400PSI	2-1/2", 30PSI, RL	CGA510	7/8" - 14LH(M)
155Y-15-3					CGA300		
155IN-125	INERT GAS (Ar, He, N ₂)	3000	5-125	2-1/2", 4000PSI	2-1/2", 200PSI	CGA580	7/8" - 14RH(M)
155IN-200			10-200		2-1/2", 400PSI		
155Q-125	AIR	3000	5-125	2-1/2", 4000PSI	2-1/2", 200PSI	CGA346	7/8" - 14RH(M)
155Q-200			10-200		2-1/2", 400PSI		
155H-200	HYDROGEN METHANE	3000	10-200	2-1/2", 4000PSI	2-1/2", 400PSI	CGA350	7/8" - 14LH(M)

1 psi = 0.00689 MPa = 6.895 kPa = 0.06895 bar = 0.07 kgf / cm², 1 scfh = 0.0283 m³/h = 0.472 LPM

155HF Series Single Stage Regulators

These high pressure, high flow models are designed for heavy duty cutting, industrial applications, laboratory testing, manifold installations, etc.

- Single-stage construction
- Forged brass body and housing cap
- Delrin cap bushing for smooth adjustments
- Sintered bronze inlet filter
- Piston-type construction
- 2-1/2" gauges for easy reading
- Weight: 8 lbs 10 oz
- Conforms to CGA E-4 standard for gas pressure regulators



155HF

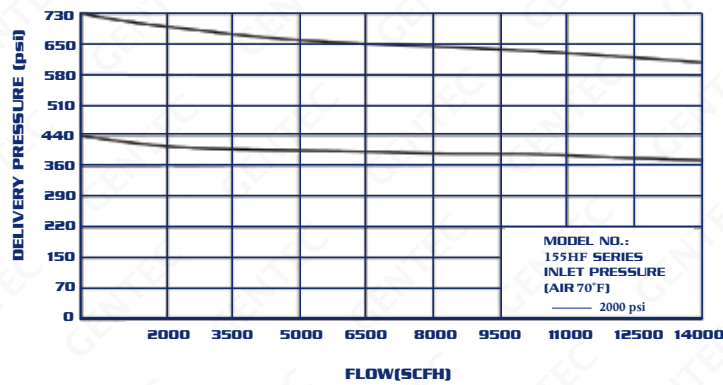

Model Number	Gas Service	Maximum Inlet Pressure (PSI)	Maximum Delivery Pressure (PSI)	Inlet Gauge	Outlet Gauge	Inlet Connection*	Outlet Connection
155HFX-800	OXYGEN	3000	500-800	2-1/2", 4000PSI	2-1/2", 2000PSI	BS3, G 5/8"-RH(M)	G 3/8" - RH(M)
155HFIN-600	Ar, He, N ₂	3000	500-800	2-1/2", 4000PSI	2-1/2", 2000PSI	BS8, G 0.860"-14RH(F)	G 3/8" - RH(M)

*Products can be ordered with German (DIN) connections. Please confirm when ordering

156D SERIES

Combination Spring and Dome Loaded Regulators

Industrial Gas Apparatus

156D Series Combination Spring and Dome Loaded Regulators

These combination spring and dome loaded models are designed for high flow gas supply systems. With the combined spring and dome loading, the delivery pressure is very precise and the droop effect is minimized. Designed for high pressure and high flow applications.

- Suitable for high flow applications
- Dome loaded and spring loaded design
- Precise delivery pressure
- Up to 400m³/h flowrate (14,125 SCFH)
- Brass body
- Weight: 15 lbs 12 oz
- Conforms to CGA E-4 standard for gas pressure regulators



156D

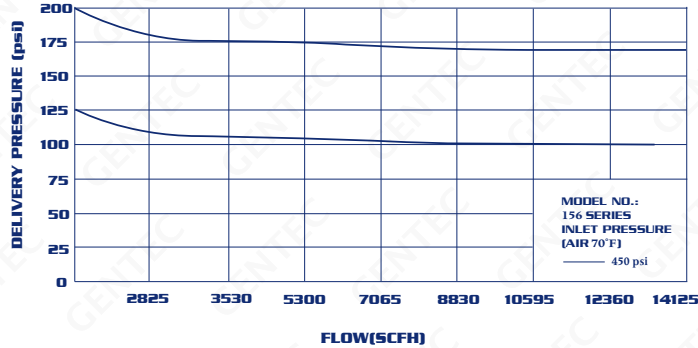

Model Number	Gas Service	Maximum Inlet Pressure (PSI)	Maximum Delivery Pressure (PSI)	Inlet Connection	Outlet Connection
156DX-125	OXYGEN	3000	0-125	1" NPT(F)	1" NPT(F)
156DIN-125	Air, N ₂ , Inert Gas	3000	0-125	1" NPT(F)	1" NPT(F)
156DIN-450	Air, N ₂ , Inert Gas	3000	0-450	1" NPT(F)	1" NPT(F)
156DH-125	H ₂	3000	0-125	1" NPT(F)	1" NPT(F)
156DLX-125	OXYGEN	400	0-125	1" NPT(F)	1" NPT(F)
156DLIN-125	Air, N ₂ , Inert Gas	400	0-125	1" NPT(F)	1" NPT(F)
156DLH-125	H ₂	400	0-125	1" NPT(F)	1" NPT(F)

152T Series Two Stage Regulators

Designed for medium duty gas welding, cutting, and heating applications. These two-stage regulators provide precise and constant delivery over a wide range of inlet pressures. Ideal for laboratory, welding, cutting, and many other applications.

- Forged brass body and housing cap
- Delrin cap bushing for smooth adjustments
- Self re-seating external pressure relief valve
- Sintered bronze inlet filter
- Stem-type seat assembly for more reliable performance
- 2" gauges for easy reading
- 1-1/4" & 2" diaphragms
- Steel Gauge Protectors are color-coded: green for Oxygen (GP21X) and red for Acetylene (GP21Y)
- Weight: 4 lbs 10 oz
- Conforms to CGA E-4 standard for gas pressure regulators



152T

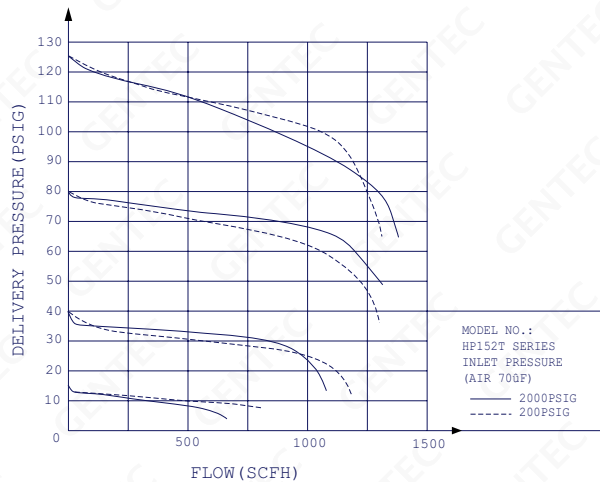

Gauge Guard Models



152TX-80G



152TY-15G
152TY-15-3G

Model Number	Gas Service	Maximum Inlet Pressure (PSI)	Maximum Delivery Pressure (PSI)	Inlet Gauge	Outlet Gauge	Inlet Connection	Outlet Connection
152TF-80	L.P. GAS	400	4-80	2", 400PSI	2", 100PSI	CGA510	9-16" - 18LH(M)
152TX-80	OXYGEN	3000	4-80	2", 4000PSI	2", 100PSI	CGA540	9-16" - 18RH(M)
152TY-15	ACETYLENE	400	2-15	2", 400PSI	2", 30PSI, RL	CGA510	9-16" - 18LH(M)
152TY-15-3						CGA300	
152TIN-125	INERT GAS (Ar, He, N2)	3000	5-125	2", 4000PSI	2", 200PSI	CGA580	5/8" - 18RH(F)
152TQ-125	AIR	3000	5-125	2", 4000PSI	2", 200PSI	CGA346	9/16" - 18RH(M)

1 psi = 0.00689 MPa = 6.895 kPa = 0.06895 bar = 0.07 kgf / cm², 1 scfh = 0.0283 m³/h = 0.472 LPM

153T SERIES

Heavy Duty Two Stage Regulators

Industrial Gas Apparatus

153T Series Two Stage Regulators

Designed for heavy duty gas welding, cutting, and heating applications. These two-stage regulators provide precise and constant delivery over a wide range of inlet pressures. Ideal for laboratory, welding, cutting, and many other applications.

- Forged brass body and housing cap
- Delrin cap bushing for smooth adjustments
- Self re-seating external pressure relief valve
- Sintered bronze inlet filter
- Steel Gauge Protectors are color coded: green for Oxygen (GP21X) and red for Acetylene (GP21Y)
- Stem-type seat assembly for more reliable seating
- 2-1/2" gauges for easy reading
- 2" and 3-1/4" diaphragms
- Weight: 7 lbs 6 oz
- Conforms to CGA E-4 standard for gas pressure regulators



153T

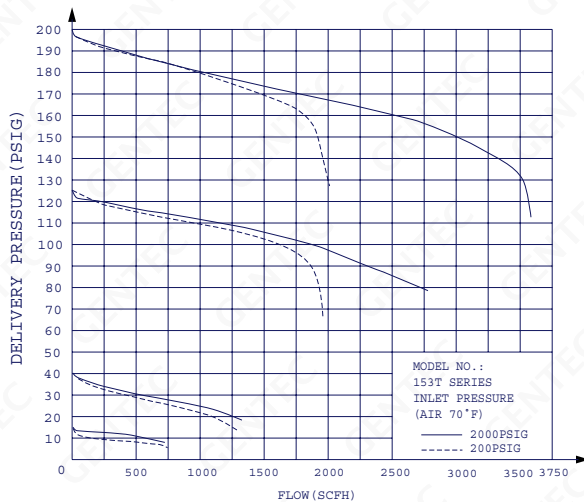

Gauge Guard Models



153TX-125G



153TY-15G
153TY-15-3G

Model Number	Gas Service	Maximum Inlet Pressure (PSI)	Maximum Delivery Pressure (PSI)	Inlet Gauge	Outlet Gauge	Inlet Connection	Outlet Connection
153TF-125	L.P. GAS	400	5-125	2-1/2", 400PSI	2-1/2", 200PSI	CGA510	9/16" - 18LH(M)
153TX-125	OXYGEN	3000	5-125	2-1/2", 4000PSI	2-1/2", 200PSI	CGA540	9/16" - 18RH(M)
153TX-250			10-250		2-1/2", 400PSI		
153TY-15	ACETYLENE	400	2-15	2-1/2", 400PSI	2-1/2", 30PSI, RL	CGA510	9/16" - 18LH(M)
153TY-15-3						CGA300	
153TIN-125	INERT GAS (Ar, He, N ₂)	3000	5-125	2-1/2", 4000PSI	2-1/2", 200PSI	CGA580	5/8" - 18RH(F)
153TIN-250			10-250		2-1/2", 400PSI		
153TQ-125	AIR	3000	5-125	2-1/2", 4000PSI	2-1/2", 200PSI	CGA590	5/8" - 18RH(F)
153TQ-200			10-200		2-1/2", 400PSI		
153TC-125	CARBON DIOXIDE	3000	5-125	2-1/2", 4000PSI	2-1/2", 200PSI	CGA320	5/8" - 18RH(F)
153TC-200			10-200		2-1/2", 400PSI		

1 psi = 0.00689 MPa = 6.895 kPa = 0.06895 bar = 0.07 kgf / cm², 1 scfh = 0.0283 m³/h = 0.472 LPM

155T Series Two Stage Regulators

Model 155T Series Compressed Gas Regulators are dual-stage extra heavy duty models designed for applications where precise and constant outlet pressures are required over a wide range of inlet pressures. Ideal for laboratory testing, manifold installations, and many other industrial applications.

- Dual-stage construction
- Forged brass body and housing cap
- Delrin cap bushing for smooth adjustments
- Self re-seating external pressure relief valve
- Conforms to CGA E-4 standard for gas pressure regulators
- Sintered bronze inlet filter
- 2-1/2" gauges for easy reading
- 2" and 3-1/4" diaphragms
- Weight: 8 lbs 8 oz



155T

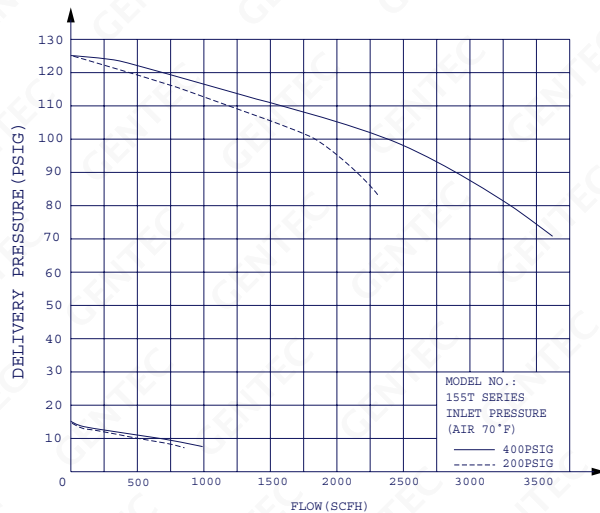

Model Number	Gas Service	Maximum Inlet Pressure (PSI)	Maximum Delivery Pressure (PSI)	Inlet Gauge	Outlet Gauge	Inlet Connection	Outlet Connection
155TF-125	L.P. GAS	400	5-125	2-1/2", 400PSI	2-1/2", 200PSI	CGA510	7/8" - 14LH(M)
155TX-125	OXYGEN	3000	5-125	2-1/2", 4000PSI	2-1/2", 200PSI	CGA540	7/8" - 14RH(M)
155TX-200			10-200		2-1/2", 400PSI		
155TY-15	ACETYLENE	400	2-15	2-1/2", 400PSI	2-1/2", 30PSI, RL	CGA510	7/8" - 14LH(M)
155TY-15-3						CGA300	
155TIN-125	INERT GAS (Ar, He, N ₂)	3000	5-125	2-1/2", 4000PSI	2-1/2", 200PSI	CGA580	7/8" - 14RH(M)
155TIN-200			10-200		2-1/2", 400PSI		
155TQ-125	AIR	3000	5-125	2-1/2", 4000PSI	2-1/2", 200PSI	CGA590	7/8" - 14RH(M)
155TQ-200			10-200		2-1/2", 400PSI		

1 psi = 0.00689 MPa = 6.895 kPa = 0.06895 bar = 0.07 kgf / cm², 1 scfh = 0.0283 m³/h = 0.472 LPM

462TF SERIES

High Pressure Two Stage Regulator

Industrial Gas Apparatus

462TF Series Two Stage Regulator

Designed for use with CNG cylinders, the 462TF prevents freezing through a unique heat sink design. The heat transfers through the heat sink preventing frost from forming. The two-stage regulator offers a very steady and precise outlet pressure



462TF

- Two-stage regulator offers a steady outlet pressure
- Unique aluminum heat sink fin design prevents freezing
- Special outlet connector with heat sink further prevents freezing
- Brass high pressure core
- 2" dual scale pressure gauges
- Weight: 5 lbs 8 oz
- Conforms to CGA E-4 standard for gas pressure regulators

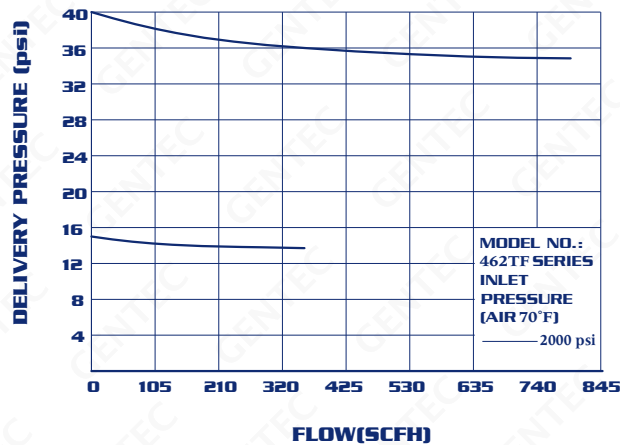

Model Number	Gas Service	Maximum Inlet Pressure (PSI)	Maximum Delivery Pressure (PSI)	Maximum Delivery Flow	Inlet Gauge	Outlet Gauge	Inlet Connection*	Outlet Connection
462TF-40	CNG	3600	0-36	0-350 SCFH	2", 6000PSI	2", 60PSI	BS2, G 5/8" - LH(M)	G 3/8" - LH(M)

*Products can be ordered with German (DIN) connections or U.S.A. (CGA) connections. Please confirm when ordering.

152S Series Station Regulators

Designed for use with gas distribution systems with light to medium flow applications. Maximum inlet pressure of 200 PSIG.
NOT FOR USE ON CYLINDERS.

- Forged brass body and housing cap
- Single-stage construction
- 2-1/2" gauge for easy reading
- Weight: 2 lbs
- Conforms to CGA E-4 standard for gas pressure regulators



152S

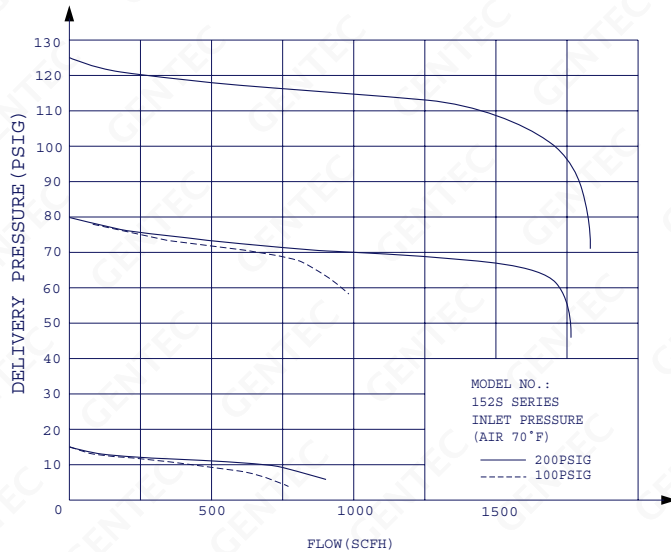

Model Number	Gas Service	Maximum Inlet Pressure (PSI)	Maximum Delivery Pressure (PSI)	Inlet Gauge	Outlet Gauge	Inlet Connection	Outlet Connection
152SF-80	L.P. GAS	200	4-80	NONE	2", 100PSI	7/8" - 14LH(F)	9/16" - 18LH(M)
152SF-125			5-125		2", 200PSI		
152SX-40	OXYGEN	200	2-40	NONE	2", 60PSI	7/8" - 14RH(F)	9/16" - 18RH(M)
152SX-80			4-80		2", 100PSI		
152SX-125			5-125		2", 200PSI		
152SY-15	ACETYLENE	200	2-15	NONE	2", 30PSI, RL	7/8" - 14LH(F)	9/16" - 18LH(M)
152SIN-40	AIR INERT GAS CO ₂	200	2-40	NONE	2", 60PSI	7/8" - 14RH(M)	5/8" - 18RH(F)
152SIN-80			4-80		2", 100PSI		
152SIN-125			5-125		2", 200PSI		
152SIN-40FG			0-40 SCFH		0-40 SCFH		

1 psi = 0.00689 MPa = 6.895 kPa = 0.06895 bar = 0.07 kgf / cm², 1 scfh = 0.0283 m³/h = 0.472 LPM

853S SERIES

Medium-Heavy Duty Station Regulators

Industrial Gas Apparatus

853S Series Station Regulators

Designed for medium to high flow gas distribution systems in medium to heavy duty flow applications. Maximum inlet pressure of 200 PSIG.

NOT FOR USE ON CYLINDERS.

- Forged brass body and housing cap
- Delrin cap bushing for smooth adjustments
- Single-stage construction
- Weight: 3 lbs 5 oz
- Conforms to CGA E-4 standard for gas pressure regulators



853S

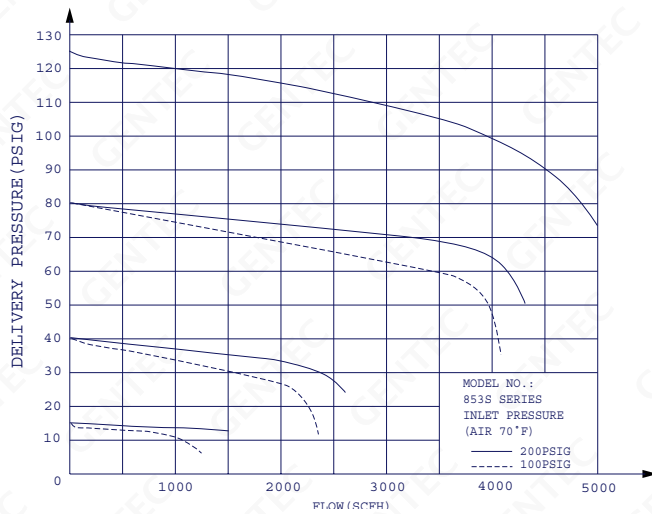

Model Number	Gas Service	Maximum Inlet Pressure (PSI)	Maximum Delivery Pressure (PSI)	Inlet Gauge	Outlet Gauge	Inlet Connection	Outlet Connection
853SF-80	L.P. GAS	200	4-80	NONE	2-1/2", 100PSI	7/8" - 14LH(F)	9/16" - 18LH(M)
853SX-40	OXYGEN	200	2-40	NONE	2-1/2", 60PSI	7/8" - 14RH(F)	9/16" - 18RH(M)
853SX-80			4-80		2-1/2", 100PSI		
853SX-125			5-125		2-1/2", 200PSI		
853SY-15	ACETYLENE	200	2-15	NONE	2-1/2", 30PSI, RL	7/8" - 14LH(F)	9/16" - 18LH(M)

1 psi = 0.00689 MPa = 6.895 kPa = 0.06895 bar = 0.07 kgf / cm², 1 scfh = 0.0283 m³/h = 0.472 LPM

853SR Series Station Regulators

Designed for medium to high flow gas distribution systems in medium to heavy duty flow applications. Maximum inlet pressure of 200 PSIG.

NOT FOR USE ON CYLINDERS.

- Forged brass body and housing cap
- Single-stage construction
- Rear entry
- 2-1/2" gauge for easy reading
- Weight: 3 lbs 5 oz
- Conforms to CGA E-4 standard for gas pressure regulators



853SR

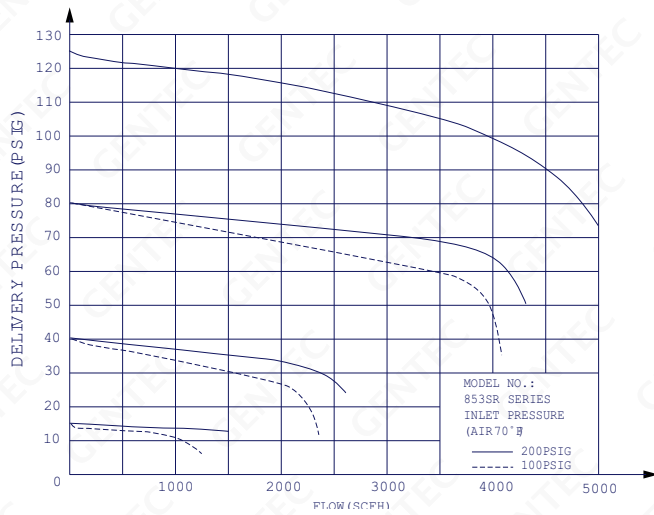

Model Number	Gas Service	Maximum Inlet Pressure (PSI)	Maximum Delivery Pressure (PSI)	Inlet Gauge	Outlet Gauge	Inlet Connection	Outlet Connection
853SRF-80	L.P. GAS	200	4-80	NONE	2-1/2", 100PSI	7/8" - 14LH(F)	9/16" - 18LH(M)
853SRIN-80	INERT GAS CO ₂	200	4-80	NONE	2-1/2", 100PSI	7/8" - 14RH(M)	5/8" - 18RH(F)
853SRIN-125			5-125		2-1/2", 200PSI		
853SRX-80	OXYGEN	200	4-80	NONE	2-1/2", 100PSI	7/8" - 14RH(F)	9/16" - 18RH(M)
853SRX-125			5-125		2-1/2", 200PSI		
853SRY-15	ACETYLENE	200	2-15	NONE	2-1/2", 30PSI, RL	7/8" - 14LH(F)	9/16" - 18LH(M)

1 psi = 0.00689 MPa = 6.895 kPa = 0.06895 bar = 0.07 kgf / cm², 1 scfh = 0.0283 m³/h = 0.472 LPM

155S SERIES

Heavy Duty Station Regulators

Industrial Gas Apparatus

155S Series Station Regulators

Designed for high flow gas distribution systems in heavy duty capacity flow applications. Maximum inlet pressure of 350 PSIG.

NOT FOR USE ON CYLINDERS.

- Forged brass body and housing cap
- Single-stage construction
- 2-1/2" gauge for easy reading
- Weight: 6 lbs 10 oz
- Conforms to CGA E-4 standard for gas pressure regulators

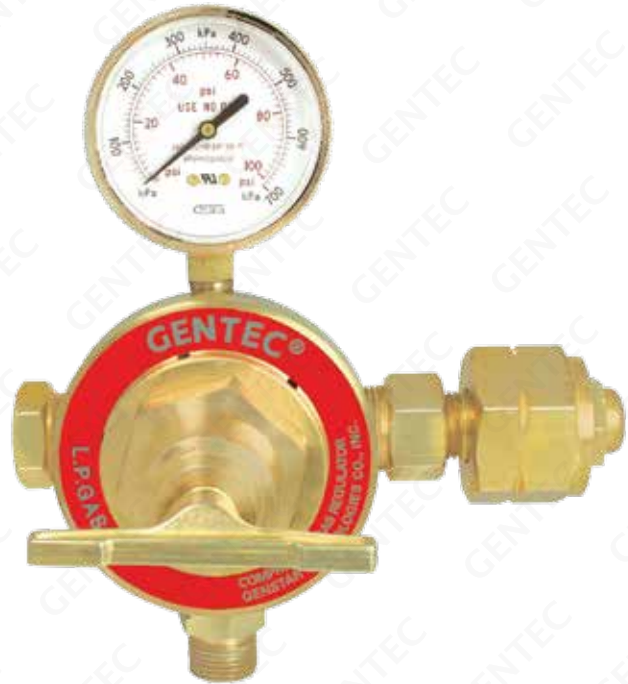

155S

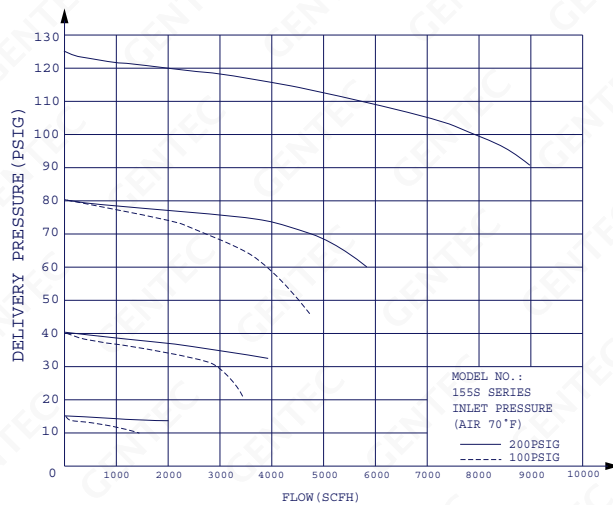

Model Number	Gas Service	Maximum Inlet Pressure (PSI)	Maximum Delivery Pressure (PSI)	Inlet Gauge	Outlet Gauge	Inlet Connection	Outlet Connection
1555F-80	L.P. GAS	350	4-80	NONE	2-1/2", 100PSI	1" - 11-1/2NPS LH(F)	7/8" - 14LH(M)
1555X-125	OXYGEN INERT GAS CO ₂	350	5-125	NONE	2-1/2", 200PSI	1" - 11-1/2NPS RH(F)	7/8" - 14RH(M)
1555Y-15	ACETYLENE	350	2-15	NONE	2-1/2", 30PSI, RL	1" - 11-1/2NPS LH(F)	7/8" - 14LH(M)

1 psi = 0.00689 MPa = 6.895 kPa = 0.06895 bar = 0.07 kgf / cm², 1 scfh = 0.0283 m³/h = 0.472 LPM

152L Series Pipeline Regulators

Designed for use with gas distribution systems in medium to heavy duty flow applications, with a maximum inlet pressure of 350 PSIG
NOT FOR USE ON CYLINDERS.

- Forged brass body and housing cap
- Single-stage construction
- Stem-type seat assembly for more reliable performance
- Delrin cap bushing for smooth adjustments
- 2" gauge for easy reading
- 2" diaphragm
- Weight: 2 lbs
- Conforms to CGA E-4 standard for gas pressure regulators



152L

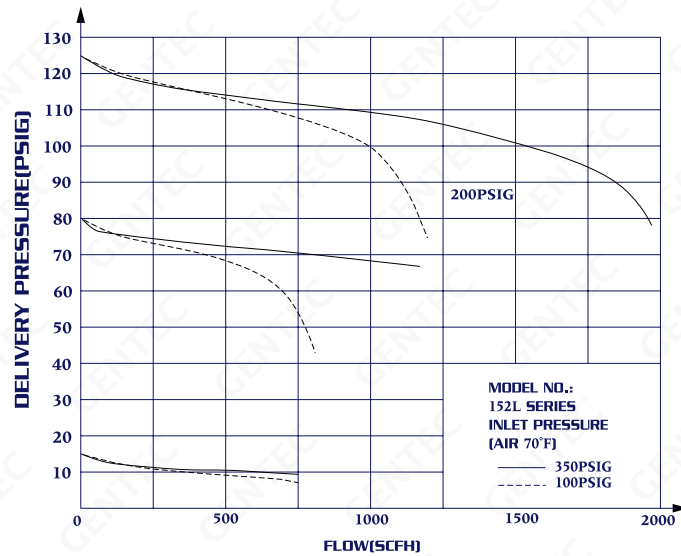

Model Number	Gas Service	Maximum Inlet Pressure (PSI)	Maximum Delivery Pressure (PSI)	Inlet Gauge	Outlet Gauge	Inlet Connection	Outlet Connection
152LF-80	L.P. GAS	350	4-80	NONE	2", 100PSI	1/4"NPT(F) PORT	1/4"NPT(F) PORT
152LX-80	OXYGEN INERT GAS CO ₂ , AIR	350	4-80	NONE	2", 100PSI	1/4"NPT(F) PORT	1/4"NPT(F) PORT
152LX-125			5-125		2", 200PSI		
152LX-200			10-200		2", 400PSI		
152LY-15	ACETYLENE	350	2-15	NONE	2", 30PSI, RL	1/4"NPT(F) PORT	1/4"NPT(F) PORT

1 psi = 0.00689 MPa = 6.895 kPa = 0.06895 bar = 0.07 kgf / cm², 1 scfh = 0.0283 m³/h = 0.472 LPM

853L SERIES

Medium-Heavy Duty Pipeline Regulators

Industrial Gas Apparatus

853L Series Pipeline Regulators

Designed for use with gas distribution systems in medium to heavy flow applications, with a maximum inlet pressure of 350 PSIG.

NOT FOR USE ON CYLINDERS.

- Forged brass body and housing cap
- Single-stage construction
- Stem-type seat assembly for more reliable performance
- Delrin cap bushing for smooth adjustments
- 2-1/2" gauge for easy reading
- 2-3/4" neoprene diaphragm
- Weight: 3 lbs 5 oz
- Conforms to CGA E-4 standard for gas pressure regulators



853L

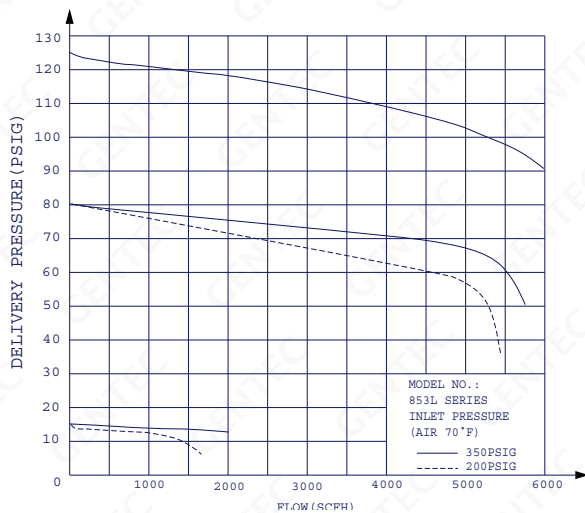

Model Number	Gas Service	Maximum Inlet Pressure (PSI)	Maximum Delivery Pressure (PSI)	Inlet Gauge	Outlet Gauge	Inlet Connection	Outlet Connection
853LF-125	L.P. GAS	350	5-125	NONE	2-1/2", 200PSI	1/4"NPT(F) PORT	1/4"NPT(F) PORT
853LX-125	OXYGEN INERT GAS CO ₂ , AIR	350	5-125	NONE	2-1/2", 200PSI	1/4"NPT(F) PORT	1/4"NPT(F) PORT
853LY-15	ACETYLENE	350	2-15	NONE	2-1/2", 30PSI, RL	1/4"NPT(F) PORT	1/4"NPT(F) PORT

1 psi = 0.00689 MPa = 6.895 kPa = 0.06895 bar = 0.07 kgf / cm², 1 scfh = 0.0283 m³/h = 0.472 LPM

155L Series Pipeline Regulators

Designed for use with heavy flow gas distribution systems, with a maximum inlet pressure of 350 PSIG
NOT FOR USE ON CYLINDERS.

- Forged brass body and housing cap
- Single-stage construction
- Stem-type seat assembly for more reliable performance
- Delrin cap bushing for smooth adjustments
- 2-1/2" gauge for easy reading
- 3-1/4" stainless steel diaphragm
- Weight: 5 lbs 2 oz
- Conforms to CGA E-4 standard for gas pressure regulators



155L

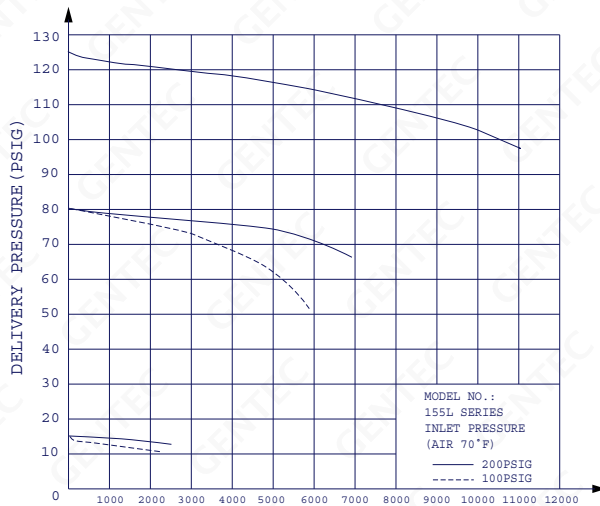

Model Number	Gas Service	Maximum Inlet Pressure (PSI)	Maximum Delivery Pressure (PSI)	Inlet Gauge	Outlet Gauge	Inlet Connection	Outlet Connection
155LF-125	L.P. GAS	350	5-125	NONE	2-1/2", 200PSI	3/4"NPT(F) PORT	3/4"NPT(F) PORT
155LF-200			10-200		2-1/2", 400PSI		
155LX-80	OXYGEN INERT GAS CO ₂ , AIR	350	4-80	NONE	2-1/2", 100PSI	3/4"NPT(F) PORT	3/4"NPT(F) PORT
155LX-125			5-125		2-1/2", 200PSI		
155LX-200			10-200		2-1/2", 400PSI		
155LY-15	ACETYLENE	350	2-15	NONE	2-1/2", 30PSI, RL	3/4"NPT(F) PORT	3/4"NPT(F) PORT

1 psi = 0.00689 MPa = 6.895 kPa = 0.06895 bar = 0.07 kgf / cm², 1 scfh = 0.0283 m³/h = 0.472 LPM

153M SERIES

Heavy Duty Manifold Regulators

Industrial Gas Apparatus

153M Series Manifold Regulators

Model 153M Series Manifold Regulators are specially designed for manifold systems. They are ideal for use with heavy flow gas distribution systems.

- Single-stage construction
- Forged brass body and housing cap
- Delrin cap bushing for smooth adjustments
- Sintered bronze inlet filter
- 2-1/2" gauges for easy reading
- 3-1/4" stainless steel diaphragm
- Conforms to CGA E-4 standard for gas pressure regulators



153M

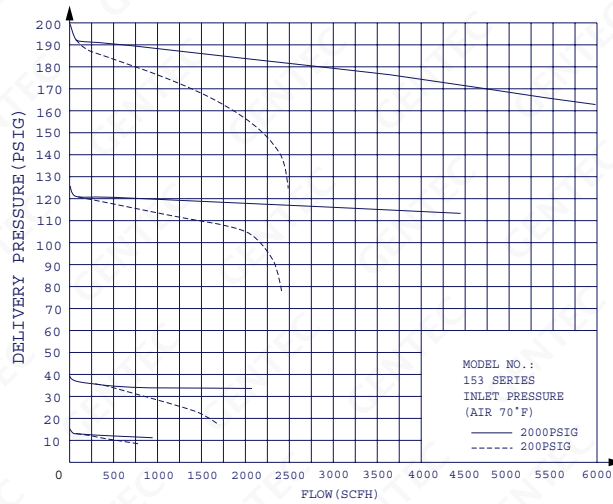

Model Number	Gas Service	Maximum Inlet Pressure (PSI)	Maximum Delivery Pressure (PSI)	Inlet Gauge	Outlet Gauge	Inlet Connection	Outlet Connection
153MF-40	L.P. GAS	400	2-40	2-1/2", 400PSI	2-1/2", 60PSI	1" - 11-1/2NPS LH(M)	1" - 11-1/2NPS LH(F)
153MF-125			5-125		2-1/2", 200PSI		
153MX-125	OXYGEN INERT GAS CO ₂ , AIR	3000	5-125	2-1/2", 4000PSI	2-1/2", 200PSI	1" - 11-1/2NPS RH(M)	1" - 11-1/2NPS RH(F)
153MX-200			10-200		2-1/2", 400PSI		
153MY-15	ACETYLENE	400	2-15	2-1/2", 400PSI	2-1/2", 30PSI, RL	1" - 11-1/2NPS LH(M)	1" - 11-1/2NPS LH(F)

1 psi = 0.006895 MPa = 6.895 kPa = 0.06895 bar = 0.07 kgf / cm², 1 scfh = 0.0283 m³/h = 0.472 LPM

153TM Series Two Stage Manifold Regulators

Model 153TM Series Manifold Regulators are specially designed for manifold systems. They are ideal for use with heavy flow gas distribution systems.

- Dual-stage construction
- Delrin cap bushing for smooth adjustments
- Forged brass body and housing cap
- Sintered bronze inlet filter
- 2-1/2" gauges for easy reading
- 2" & 3-1/4" stainless steel diaphragms
- Conforms to CGA E-4 standard for gas pressure regulators



153TM

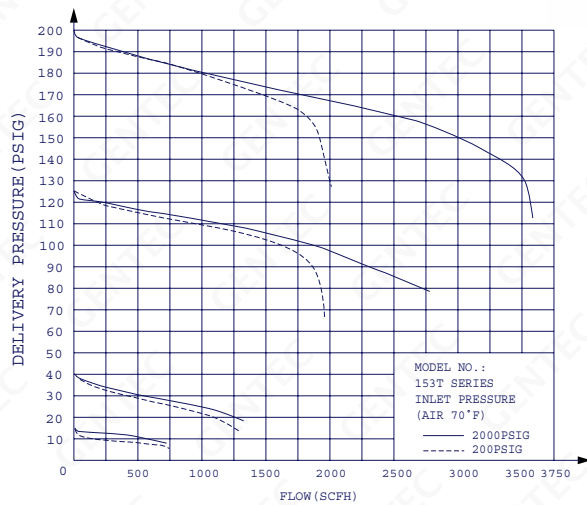

Model Number	Gas Service	Maximum Inlet Pressure (PSI)	Maximum Delivery Pressure (PSI)	Inlet Gauge	Outlet Gauge	Inlet Connection	Outlet Connection
153TMX-125	OXYGEN INERT GAS CO ₂ , AIR	3000	5-125	2-1/2", 4000PSI	2-1/2", 200PSI	1" - 11-1/2NPS RH(M)	1" - 11-1/2NPS RH(F)
153TMY-15	ACETYLENE	400	2-15	2-1/2", 400PSI	2-1/2", 30PSI, RL	1" - 11-1/2NPS LH(M)	1" - 11-1/2NPS LH(F)

1 psi = 0.00689 MPa = 6.895 kPa = 0.06895 bar = 0.07 kgf / cm², 1 scfh = 0.0283 m³/h = 0.472 LPM

155M SERIES

Extra Heavy Duty Manifold Regulators

Industrial Gas Apparatus

155M Series Manifold Regulators

Model 155M Series Manifold Regulators are specially designed for manifold systems. They are ideal for use with extra heavy flow gas distribution systems.

- Single-stage construction
- Forged brass body and housing cap
- Delrin cap bushing for smooth adjustments
- Sintered bronze inlet filter
- 2-1/2" gauges for easy reading
- 3-1/4" stainless steel diaphragm
- Conforms to CGA E-4 standard for gas pressure regulators



155M

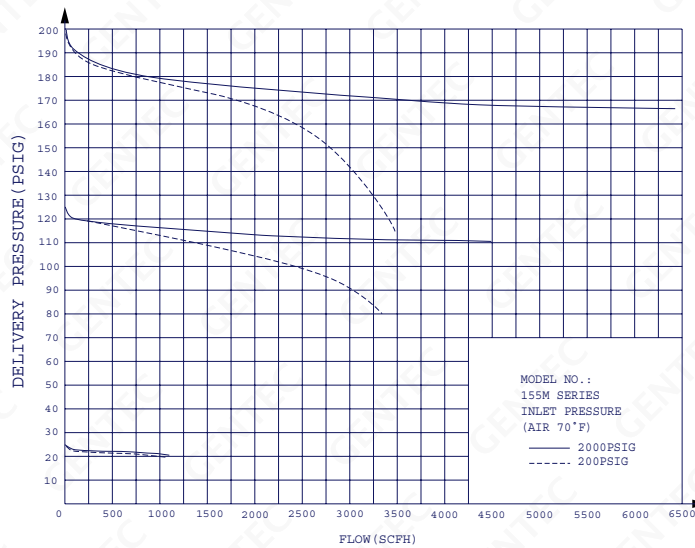

Model Number	Gas Service	Maximum Inlet Pressure (PSI)	Maximum Delivery Pressure (PSI)	Inlet Gauge	Outlet Gauge	Inlet Connection	Outlet Connection
155MIN-125	OXYGEN	3000	5-125	2-1/2", 4000PSI	2-1/2", 200PSI	1" - 11-1/2NPS RH(M)	1" - 11-1/2NPS RH(F)
155MIN-200	INERT GAS CO ₂ , AIR		10-200		2-1/2", 400PSI		
155MY-15	ACETYLENE	400	2-15	2-1/2", 400PSI	2-1/2", 30PSI, RL	1" - 11-1/2NPS LH(M)	1" - 11-1/2NPS LH(F)

1 psi = 0.00689 MPa = 6.895 kPa = 0.06895 bar = 0.07 kgf / cm², 1 scfh = 0.0283 m³/h = 0.472 LPM

155TM Series Two Stage Manifold Regulators

Model 155TM Series Manifold Regulators are specially designed for manifold systems. They are ideal for use with extra heavy flow gas distribution systems.

- Dual-stage construction
- Forged brass body and housing cap
- Delrin cap bushing for smooth adjustments
- Sintered bronze inlet filter
- 2-1/2" gauges for easy reading
- 2" & 3-1/4" stainless steel diaphragms
- Conforms to CGA E-4 standard for gas pressure regulators



155TM

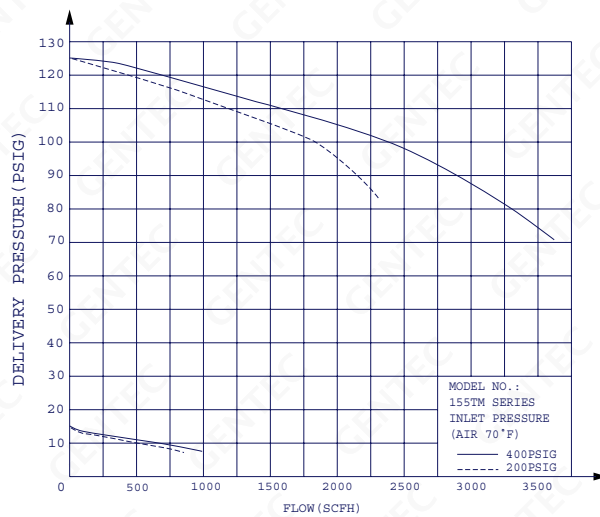

Model Number	Gas Service	Maximum Inlet Pressure (PSI)	Maximum Delivery Pressure (PSI)	Inlet Gauge	Outlet Gauge	Inlet Connection	Outlet Connection
155TMIN-125	OXYGEN	3000	5-125	2-1/2", 4000PSI	2-1/2", 200PSI	1" - 11-1/2NPS RH(M)	1" - 11-1/2NPS RH(F)
155TMIN-200	INERT GAS CO ₂ , AIR		10-200		2-1/2", 400PSI		
155TMY-15	ACETYLENE	400	2-15	2-1/2", 400PSI	2-1/2", 30PSI, RL	1" - 11-1/2NPS LH(M)	1" - 11-1/2NPS LH(F)

1 psi = 0.00689 MPa = 6.895 kPa = 0.06895 bar = 0.07 kgf / cm², 1 scfh = 0.0283 m³/h = 0.472 LPM

190 SERIES

Light Duty Flow Gauge Regulators

Industrial Gas Apparatus

190AR1 Series Flow Gauge Regulators

Model 190AR1 Series Flow Gauge Regulators are designed for light duty MIG applications to provide accurate regulation of gas flow, and reliable performance in commercial, industrial and laboratory applications.

- 2" flow gauge for easy reading
- Body machined from class "A" brass
- Chrome plated housing cap
- Internal pressure relief design
- Sintered bronze inlet filter
- Plastic adjustment knob for smooth "easy touch" flow settings
- 0 - 50 SCFH argon (Ar) flow
- Weight: 1 lb 15 oz
- UL listed



190AR1

Model Number	Gas Service	Flow Capacity (SCFH)	Inlet Gauge	Outlet Gauge	Inlet Connection	Outlet Connection
190AR1-50	ARGON, AR/CO ₂ MIX	0-50	NONE	2", 50SCFH	CGA580	5/8" - 18RH(F), .032 ORIFICE
190AR1-50-B						3/16" BARB, .032 ORIFICE
190AR1-50-P						5/32" PUSH-IN-TUBE, .032 ORIFICE

1 psi = 0.00689 MPa = 6.895 kPa = 0.06895 bar = 0.07 kgf / cm², 1 scfh = 0.0283 m³/h = 0.472 LPM

190 Series Flow Gauge Regulators

Model 190 Series "MIG METER" Flow Gauge Regulators are designed for MIG & TIG applications to provide accurate regulation of gas flow. They are ideal for commercial, industrial and laboratory applications.

- 2" gauges for easy reading
- Forged brass body and housing cap
- Chrome plated housing cap
- Internal pressure relief design
- Accurate measurement of gas flow up to 50 SCFH
- Choice of inlet connections for argon (CGA 580) or carbon dioxide (CGA 320)
- Plastic adjustment knob for smooth "easy touch" flow settings
- Weight: 2 lbs 3 oz
- UL listed



190AR

Model Number	Gas Service	Flow Capacity (SCFH)	Inlet Gauge	Outlet Gauge	Inlet Connection	Outlet Connection
190AR-50	ARGON, AR/CO ₂ MIX	0-50	2", 4000PSI	2", 50SCFH	CGA580	5/8" - 18RH(F), .032 ORIFICE
190AR-50-B						3/16" BARB, .032 ORIFICE
190AR-50-P						5/32" PUSH-IN-TUBE, .032 ORIFICE
190CD-45	CARBON DIOXIDE	0-45	2", 4000PSI	2", 50SCFH	CGA320	5/8" - 18RH(F), .032 ORIFICE

1 psi = 0.00689 MPa = 6.895 kPa = 0.06895 bar = 0.07 kgf / cm², 1 scfh = 0.0283 m³/h = 0.472 LPM

152 Series Flow Gauge Regulators

Model 152 Series Flow Gauge Regulators are designed for MIG & TIG applications to provide accurate regulation of gas flow. They also provide reliable performance in commercial, industrial and laboratory applications.

- Accurate measurement of gas flow up to 100 SCFH
- Body and housing cap are machined from class "A" brass
- External pressure relief valve
- Lightweight, rugged construction
- Sintered bronze inlet filter
- Stem type seat assembly for more reliable performance
- Weight: 2 lbs 15 oz



152CD

Model Number	Gas Service	Flow Capacity (SCFH)	Inlet Gauge	Outlet Gauge	Inlet Connection	Outlet Connection
152AR-100	ARGON, AR/CO ₂ MIX	0-100	2", 4000PSI	2", 100SCFH	CGA580	5/8" - 18RH(F), .032 ORIFICE
152CD-100	CARBON DIOXIDE	0-100	2", 4000PSI	2", 100SCFH	CGA320	5/8" - 18RH(F), .032 ORIFICE

1 psi = 0.00689 MPa = 6.895 kPa = 0.06895 bar = 0.07 kgf / cm², 1 scfh = 0.0283 m³/h = 0.472 LPM

220, 227 & 229 SERIES

Compact Pre-Set Gas Regulators

Industrial Gas Apparatus

Model 220 “PACER” Flow Regulators are designed for light duty MIG applications where compact size and preset delivery flow are desirable. Piston-type mechanism provides reliable performance.

- “Piston” type cylinder pressure indicator
- 30 SCFH preset argon flow
- Integral CGA 580 inlet with sintered bronze inlet filter
- Weight: 9.7 oz



220-50

Model Number	Gas Service	Maximum Delivery Pressure (PSI)	Inlet Gauge	Outlet Gauge	Inlet Connection	Outlet Connection	Equivalent
220-50	ARGON, AR/CO ₂ MIX	50	PISTON INDICATOR	NONE	CGA580	3/16" BARB, .032 ORIFICE	F.R.O.G.

227 Series Flow Regulators

Model 227 Series Flow Regulators are designed for light duty applications using carbon dioxide (CO₂) or nitrogen (N₂). Preset delivery available for six pressure settings: 50, 75, 100, 125, 150 & 175 PSI. To order, add pressure number after the series number. For example, 227C-150 for preset delivery pressure 150PSI.

- “Piston” type mechanism for reliability
- Body machined from class “A” brass bar stock
- Sintered bronze inlet filter
- 1/4" NPT outlet port
- Weight w/o gauge: 14.5 oz w/gauge: 16 oz
- 1-1/2" rear entry color-coded cylinder contents gauge (Model 227CG & 227NG)



227C-50



227CG-100

Regulator Series	Gas Service	Available Present Pressure (PSI)	Inlet Gauge	Outlet Gauge	Inlet Connection	Outlet Connection
227C	CARBON DIOXIDE	50, 75, 100, 125, 150, 175	NONE	NONE	CGA320	1/4" NPT(F) PORT
227CG			1-1/2" 3000PSI REAR			
227N	ARGON, AR/CO ₂ MIX		NONE			
227NG			1-1/2" 3000PSI REAR			

229 Series Flow Regulators

Model 229 Series Flow Regulators are designed for light duty MIG applications where compact size and preset delivery flow are desirable. Piston-type mechanism provides reliable performance.

- 40 SCFH preset argon flow
- Integral CGA 580 inlet with sintered bronze inlet filter
- Choice of 3/16" barbed or 5/32" push-to-connect outlet
- Weight: 11.9 oz



229-50-B



229-50-P

Model Number	Gas Service	Maximum Delivery Pressure (PSI)	Inlet Gauge	Outlet Gauge	Inlet Connection	Outlet Connection
229-50-B	ARGON, AR/CO ₂ MIX	50	NONE	NONE	CGA580	3/16" BARB, .032 ORIFICE
229-50-P						5/32" PUSH-IN-TUBE, .032 ORIFICE

191 Series Flowmeter Regulators

Model 191 Series Flowmeter Regulators are designed for MIG & TIG applications to provide accurate regulation of gas flow. They are also ideal for commercial, industrial and laboratory applications.

- Combination of regulator and flowmeter as one compact unit
- Regulator is preset at 50 PSIG
- Piston-type construction
- Body machined from class "A" brass
- Internal pressure relief valve
- Polycarbonate flow tube and hood are impact resistant for maximum durability and service life
- Calibrated for argon, CO₂, helium, nitrogen, air, and 75% argon / 25% CO₂ mixed gases
- Backpressure compensated to ensure accurate readings when line restrictions are present
- Sintered bronze inlet filter
- Comes with 5/8"-18RH Female fitting (with the attached Adaptor) and 9/16"-18RH
- Male fitting (without adaptor)
- Weight: 1 lbs 10 oz
- Conforms to CGA E-4 Standard for Gas Pressure Regulators

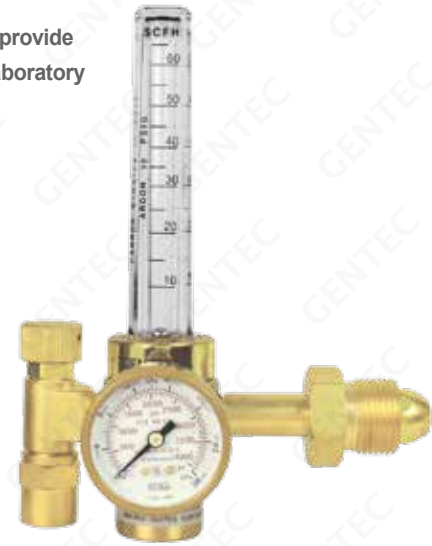

191

Model Number	Gas Service	Outlet Pressure Preset (PSI)	Inlet Gauge	Flowmeter (SCFH)	Inlet Connection	Outlet Connection
191AR-60	ARGON, AR/CO ₂ MIX	50	1-1/2", 4000PSI	60	CGA580	5/8" - 18RH(F)/9/16"-18RH(M)
191HE-150	HELIUM			150	CGA580	
191CD-60	CARBON DIOXIDE			60*	CGA320	
191NR-70	NITROGEN			70	CGA580	
191QR-70	AIR			70	CGA590	

*Maximum Actual Flow 30SCFH with Continuous Cold Carbon Dioxide

791AR-60 Flowmeter Regulator

791AR-60 Economical Flowmeter Regulator is designed for light duty MIG & TIG applications.

- Compact lightweight construction
- Piston-type construction
- Forged Brass Body
- Calibrated for argon, and 75% argon / 25% CO₂ mixed gases
- Backpressure compensated to ensure accurate readings
- Sintered bronze inlet filter
- Compact Inlet Gauge



791AR

Model Number	Gas Service	Outlet Pressure Preset (PSI)	Inlet Gauge	Flowmeter (SCFH)	Inlet Connection	Outlet Connection
791AR-60	ARGON, AR/CO ₂ MIX	50	1-1/2", 4000PSI	60	CGA580	5/8" - 18RH(F)

195 & 195T SERIES

Heavy Duty Flowmeter Regulators

Industrial Gas Apparatus

195 & 195T Heavy Duty "MIG MASTER" Flowmeter Regulators

Model 195 Series "MIG MASTER" Flowmeter Regulators are designed for MIG & TIG applications to provide accurate regulation of gas flow. They are also ideal for commercial, industrial, and laboratory applications.

- Regulator is preset at 50PSIG
- 195 Series has single-stage construction and 195T Series has two-stage construction
- Polycarbonate flow tube and hood are impact resistant for maximum durability and service life
- Calibrated for argon, helium, carbon dioxide and 75% argon / 25% CO₂ mixed gases
- Flowmeter is backpressure compensated to ensure accurate readings when line restrictions are present
- 2" high-pressure gauge for easy reading
- Body machined from class "A" brass
- Chrome-plated housing cap of regulator
- Internal pressure relief design
- Sintered bronze inlet filter
- Weight: 2 lbs 15 oz
- UL Listed



Model Number	Gas Service	Outlet Pressure Preset (PSI)	Inlet Gauge	Flowmeter (SCFH)	Inlet Connection	Outlet Connection
195AR-60	ARGON	50	2", 4000PSI	60	CGA580	5/8" - 18RH(F)
195AR-60-680			2", 6000PSI		CGA680	
195HE-150	HELIUM		2", 4000PSI	150	CGA580	
195HE-150-680			2", 6000PSI		CGA680	
195CD-60	CARBON DIOXIDE		2", 4000PSI	60*	CGA320	
195TAR-60	ARGON		50	2", 4000PSI	60	
195THE-150	HELIUM	150			CGA580	
195TCD-60	CARBON DIOXIDE	60*			CGA320	

*Maximum Actual Flow 30SCFH with Continuous Cold CO₂

MIG/TIG Shielding Gas Kits-Flowmeter /Flowgauge Regulator with 1/4"x6' and 1/4"x10' Hoses



190AR-50-6HSP



195AR-60-6HSP



791AR-60-6HSP

Model Number	Gas Service	Package Type	Flowgauge / Flowmeter (SCFH)	Regulator Type	Regulator Model Number	Blue Hose
190AR1-50-6HSP	ARGON	SKIN PACKAGE	50	FLOWGAUGE	190AR1-50	1/4"x 6'
190AR-50-6HSP					190AR-50	1/4"x 10'
190AR-50-10HSP						
190CD-45-6HSP	CARBON DIOXIDE	SKIN PACKAGE	50	FLOWGAUGE	190CD-45	1/4"x 6'
191AR-60-6HSP	ARGON, AR/CO ₂ MIX	SKIN PACKAGE	60	FLOWMETER	191CD-60	1/4"x 6'
191AR-60-10HSP					191CD-60	1/4"x 10'
191AR-60-6HSP		CLAM SHELL				191CD-60
191CD-60-6HSP	CARBON DIOXIDE	SKIN PACKAGE	60	FLOWMETER	191CD-60	1/4"x 6'
191CD-60-6HCS		CLAM SHELL				
791AR-60-6HSP	ARGON, AR/CO ₂ MIX	SKIN PACKAGE	60	FLOWMETER	791AR-60	1/4"x 6'
195AR-60-6HSP					195AR-60	
195CD-60-6HSP	CARBON DIOXIDE	SKIN PACKAGE	60	FLOWMETER	195CD-60	1/4"x 6'

196 DUAL & 195FM SERIES

Dual Flowmeter Regulators & Flowmeters

Industrial Gas Apparatus

196 Series Dual Flowmeter Regulators

Model 196 Series Flowmeter Regulators are designed for MIG & TIG applications to provide accurate regulation of gas flow. They are also ideal for commercial industrial and laboratory applications.

- Regulator is preset at 50PSIG
- Body machined from class "A" brass
- Single-stage construction
- Monitoring two separate gas flow settings at the same time
- 2" gauge and two 195FM flowmeters
- Polycarbonate flow tube and hood are impact resistant for maximum durability and service life
- Calibrated for argon, helium and 75% argon / 25% CO₂ mixed gases
- Flowmeter is backpressure compensated to ensure accurate readings when line restrictions are present
- Sintered bronze inlet filter
- Weight: 4 lbs 10 oz
- Conforms to CGA E-4 Standard for Gas Pressure Regulators



196

Model Number	Gas Service	Outlet Pressure Preset (PSI)	Inlet Gauge	Flowmeter (SCFH)	Inlet Connection	Outlet Connection
196AR-60	ARGON, AR/CO ₂ MIX	50	2", 4000PSI	60	CGA580	5/8" - 18RH(F)
196HE-150	HELIUM			150		

195FM Series Flowmeters

Model 195FM Series Flowmeters are designed for accurate regulation of gas flow.

- Maximum inlet pressure 50PSI
- Body machined from class "A" brass
- Polycarbonate flow tube and hood are impact resistant for maximum durability and service life
- Backpressure compensated design ensures accurate readings when line restrictions are present
- Calibrated for argon, CO₂ and 75% argon / 25% CO₂ mixed gases at 50 PSI inlet pressure
- Easy to "fine-tune" flow settings with adjustable brass knob
- Weight: 1 lb 2 oz
- UL Listed



195FM

Model Number	Gas Service	Maximum Inlet Preset (PSI)	Flowmeter Range (SCFH)	Inlet Connection	Outlet Connection
195FM	ARGON, AR/CO ₂ MIX	50	0-60	1/4" NPT(M)	5/8" - 18RH(F)
195FM-5				5/8"-18RH(M)	
195FM-9				9/16"-18RH(F)	
195FM-7				7/8"-14RH(F)	

198CD-60 Electrically Heated Flowmeter Regulator for CO₂

Model 198CD-60 Electrically-Heated Flowmeter Regulator for CO₂ is designed for applications requiring high gas flow rates, up to 60 SCFH without freezing.

- Regulator is preset at 50 PSI
- Thermostatically-controlled built-in electric
- Heater keeps the CO₂ warm and provides continuous duty cycle without freezing
- 110VAC / 190W heater is standard
- Voltage output will vary in some locations
- Please specify your voltage requirements when ordering
- Flowmeter is backpressure compensated to ensure accurate reading when line restrictions are present
- Forged brass body and housing cap
- Sintered bronze inlet filter
- Weight: 4 lbs 11 oz



198CD-60

Model Number	Gas Service	Outlet Pressure Preset (PSI)	Inlet Gauge	Flowmeter (SCFH)	Inlet Connection	Outlet Connection
198CD-60	CARBON DIOXIDE	50	2", 4000PSI	60	CGA320	5/8" - 18RH(F)

CAUTION: Use this regulator only with non-siphoned standard CO₂ cylinders

199CD-60 Radiator Flowmeter Regulator for CO₂

Model 199CD-60 Radiator-Type Regulator / Flowmeter for CO₂ is designed for applications requiring high gas flow rates, up to 60 SCFH without freezing.

- Flowmeter is backpressure compensated to ensure accurate reading when line restrictions are present
- Regulator is preset to deliver 50 PSI into the flowmeter which is calibrated to operate at 50 PSI
- Anodized aluminum body
- Sintered bronze inlet filter
- Weight: 4 lbs

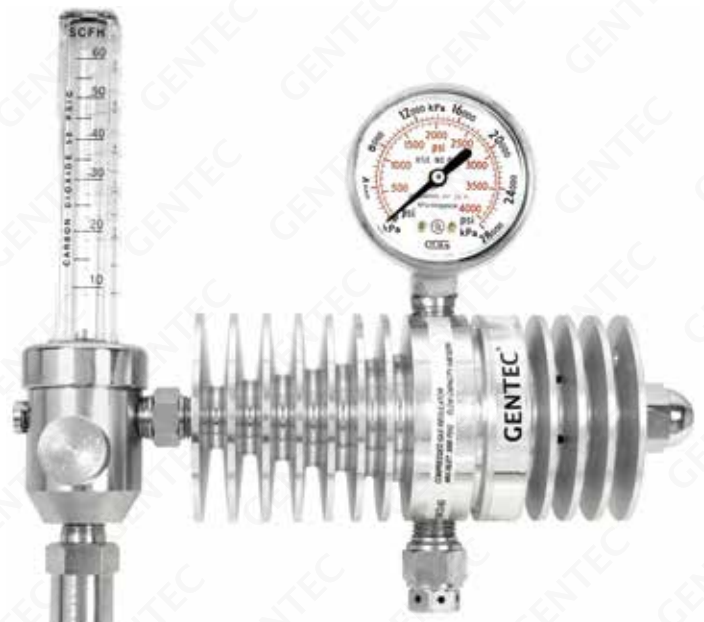

199CD-60

Model Number	Gas Service	Outlet Pressure Preset (PSI)	Inlet Gauge	Flowmeter (SCFH)	Inlet Connection	Outlet Connection
199CD-60	CARBON DIOXIDE	50	2", 4000PSI	60	CGA320	5/8" - 18RH(F)

CAUTION: Use this regulator only with non-siphoned standard CO₂ cylinders

195AE-60

Gas Saving Flowmeter Regulator Heavy Duty

Industrial Gas Apparatus

GENTEC® Gas Saving Flowmeter Regulators are designed to minimize the amount of shield gas wasted. The innovative design integrates a stabilizer onto the flowmeter providing constant pressure and flow.

How it Works: GENTEC®'s Gas Saving Flowmeter Regulator first reduces the supplied pressure to a set pressure. To help save gas, a built-in stabilizer is designed on the flowmeter to eliminate pressure fluctuations. For example, during the start of TIG/MIG applications, a gas surge results from the excess pressure in the supply hose. These surges are regarded as “wasted gas”. The Gas Saving Flowmeter Regulators use the built-in stabilizer on the flowmeter to reduce pressure surges while maintaining a constant pressure and flow, saving up to 50% of the gas*.

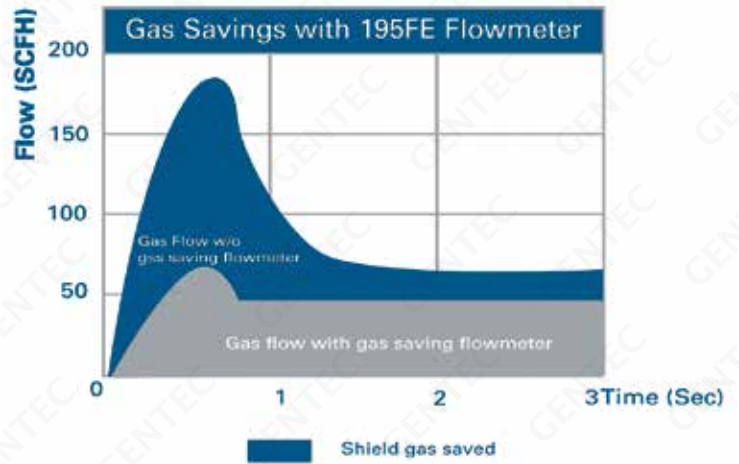

195AE-60 Gas Saving Flowmeter Regulator

- Regulator is preset at 50PSIG
- Chrome-plated brass body machined from class “A” brass
- Single-stage regulator
- Polycarbonate flow tube and hood are impact resistant for maximum durability and service life
- Flowmeter is backpressure compensated to ensure accurate readings when line restrictions are present
- Calibrated for argon and 75% argon/25% CO2 mixed gases.
- Sintered bronze inlet filter
- Flowmeter with built-in stabilizer for gas saving
- Internal pressure relief design
- Gas saving range: 20-50%*
- 2” high-pressure gauge for easy reading
- Weight: 2 lbs 15 oz
- Optional BSP, JIS, DIN inlet connections are available



195AE-60

Model Number	Gas Service	Outlet Pressure Preset (PSI)	Inlet Gauge	Flowmeter (SCFH)	Inlet Connection	Outlet Connection
195AE-60	ARGON, AR/CO ₂ MIX	50	2", 4000PSI	60	CGA580	5/8" - 18RH(F)

*Actual savings depend on specific requirements of welding operation

194CE Series Electrically Heated Gas Saving Flowmeter Regulator for CO₂

- Thermostatically-controlled built-in electric heater keeps the CO₂ warm and provides a continuous duty cycle without freezing
- Regulator is preset at 50PSIG
- Single-stage regulator
- Chrome-plated forged brass body and housing cap
- Flowmeter is backpressure compensated to ensure accurate reading when line restrictions are present
- Sintered bronze inlet filter
- Flowmeter with built-in stabilizer for gas saving
- External relief valve
- Gas saving range: 20-50%*
- 2" high-pressure gauge for easy reading
- Weight: 4 lbs 11 oz



194CE

CAUTION: Use this regulator only with non-siphoned standard CO₂ cylinders

Model Number	Gas Service	Outlet Pressure Preset (PSI)	Inlet Gauge	Flowmeter (SCFH)	Inlet Connection	Outlet Connection	Supply Voltage
194CE-60-36	CARBON DIOXIDE	50	2", 4000PSI	60	CGA320	5/8" - 18RH(F)	36VAC, 190W
194CE-60-110							110VAC, 190W
194CE-60-220							220VAC, 190W
194CE-100-36				100			36VAC, 190W
194CE-100-110							110VAC, 190W
194CE-100-220							220VAC, 190W

195FE Gas Saving Flowmeter

- Built-in stabilizer for gas saving
- Chrome-plated brass body machined from class "A" brass
- Polycarbonate flow tube and hood are impact resistant for maximum durability and service life
- Backpressure compensated design ensures accurate readings when line restrictions are present
- Easy to "fine-tune" flow settings with adjustable stainless knob
- Working pressure: 50 psi
- Gas saving range: 20-50%*
- Weight: 1 lb 2 oz



195FE

Model Number	Gas Service	Maximum Inlet Preset (PSI)	Flowmeter (SCFH)	Inlet Connection	Outlet Connection
195FE	ARGON, CO ₂ , AR/CO ₂ MIX	50	0-60	1/4" NPT(M)	5/8" - 18RH(F)

*Actual savings depend on specific requirements of welding operation

229, 230, 230HB SERIES

Balloon Filler Regulators

Industrial Gas Apparatus

229 Series "Economy Balloon Blower"

Model 229 "Economy Balloon Blower" features straight through construction, rugged brass body, and "Piston Type" mechanism.

- Hand tight CGA 580 inlet connection with sintered bronze inlet filter
- 1-1/2" rear entry color-coded cylinder contents gauge on Model 229G
- Weight w/o gauge: 11.9 oz, w/gauge: 13.9 oz

Model Number	Inlet Connection	Inlet Gauge	Accessories
229	CGA580, HAND TIGHT	NONE	NONE
229G		1-1/2" 3000PSI REAR	



229



229G

230 Series "Balloon Blower"

Model 230 "Balloon Blower" features an all-rugged brass body, "Piston Type" mechanism, drilled and tapped for tie hook and string cutter. Body contains an additional 1/4" NPT port to accommodate a second filler valve if desired.

- Wrench tight CGA 580 inlet connection with sintered bronze filter valve
- 1-1/2" rear entry color-coded cylinder contents gauge on Model 230G, 230GA
- Weight w/o gauge: 1 lb 2 oz, w/gauge: 1 lb 4 oz

Model Number	Inlet Connection	Inlet Gauge	Accessories
230	CGA580	NONE	NONE
230A			TIE HOOK, STRING CUTTER
230G		1-1/2" 3000PSI REAR	NONE
230GA			TIE HOOK, STRING CUTTER



230

230GA

230HB Series "Balloon Blower"

Model 230HB "Balloon Blower" has an all-rugged brass body and, "Piston Type" mechanism. It is drilled and tapped for a tie hook and a string cutter.

Body contains an additional 1/4" NPT port to accommodate a second filler valve if desired.

- Combination wrench/hand tight CGA 580 inlet connection with sintered bronze filter valve
- 1-1/2" rear entry color-coded cylinder contents gauge on Model 230HBG, and 230HBGA
- Weight w/o gauge: 1 lb 2 oz w/gauge: 1 lb 4 oz

Model Number	Inlet Connection	Inlet Gauge	Accessories
230HB	CGA580	NONE	NONE
230HBA			TIE HOOK, STRING CUTTER
230HBG		1-1/2" 3000PSI REAR	NONE
230HBGA			TIE HOOK, STRING CUTTER



230HB

230HBGA

230H Series “Balloon Blower”

Model 230H “Balloon Blower” features an all-rugged brass body and a “Piston Type” mechanism. It is drilled and tapped for tie hook and string cutter. Body contains an additional 1/4” NPT port to accommodate a second filler valve if desired.

- Large plastic hand tight CGA 580 inlet connection with sintered bronze inlet filter
- 1-1/2” rear entry color-coded cylinder contents gauge on Model 230HG, and 230HGA
- Weight w/o gauge: 1 lb 6 oz w/gauge: 1 lb 8 oz

Model Number	Inlet Connection	Inlet Gauge	Accessories
230H	CGA580, HAND TIGHT	NONE	NONE
230HA			TIE HOOK, STRING CUTTER
230HG		1-1/2” 3000PSI REAR	NONE
230HGA			TIE HOOK, STRING CUTTER



230HGA

230HGMYA Mylar (Foil)/Latex Balloon Regulator

Model 230HGMYA is both a standard latex and auto-fill mylar balloon inflator. All-rugged brass body and “Piston-Type” mechanism. It is drilled and tapped for a tie hook and a ribbon cutter.

- Automatic shut-off mylar filler to prevent over filling and bursting of expensive mylar balloon
- Large plastic hand tight CGA 580 inlet connection with sintered bronze inlet filter
- Tie hook and string cutter are included
- 1-1/2” rear entry color-coded cylinder contents gauge

Model Number	Inlet Connection	Inlet Gauge	Accessories
230HGMYA	CGA580, HAND TIGHT	1-1/2” 3000PSI REAR	TIE HOOK, STRING CUTTER



230HGMYA

ACCESSORIES

Balloon Filler Regulator Accessories

Industrial Gas Apparatus

Replacement Parts

Model Number	Description
GR15-3MEF	CONTENTS GAUGE, 1-1/2" x 3000PSI, REAR ENTRY
RB236	TIE HOOK, STAINLESS STEEL
RB237	STRING CUTTER
RP-2HP	BODY PLUG, 1/8"NPT
RP-4HP	BODY PLUG, 1/4"NPT



GR15-3MEF



RB236



RB237



RP-2HP



RP-4HP

Replacement Valves

Model Number	Description
RB234	TILT VALVE WITH 1/4" NPT FEMALE INLET
RB232	TILT VALVE WITH 1/4" NPT MALE BUSHING
RB205-1V	TILT VALVE WITH 1/4" NPT MALE INLET
RB205-2V	TILT VALVE WITH MYLAR TIP, WITH 1/4" NPT MALE INLET
RB205-1FV	REPLACEMENT MYLAR TIP FOR TILT VALVE
RB205-1P	PUSH VALVE, WITH 1/4" NPT MALE INLET



RB234



RB232



RB205-1V



RB205-2V



RB205-1FV



RB205-1P

Tips for RB205-1P Push Valve

Model Number	Description
RB205-1BT	LARGE LATEX BALLOON TIP
RB205-1F	MYLAR BALLOON TIP
RB205-1L	LATEX BALLOON TIP ATTACHMENT
RB205-1N	NEEDLE VALVE TIP (M)
RB205-1X	MIXER TIP, 60% HELIUM / 40% AIR



RB205-1BT



RB205-1L



RB205-1X



RB205-1F



RB205-1N

GENTEC® Nitrogen Tire Inflation Kits allow for easy and cost effective filling of automobile and truck tires with pure nitrogen. The kits are portable, easy to operate, and conform to the specifications and requirements of UL, DOT, and OSHA.

Compressed Nitrogen Gas, a dry inert gas, allows tires to last longer, perform better, and function with a greater degree of reliability than tires inflated with standard compressed air. Its large-sized molecule helps with tire pressure retention, leads to more uniform tire wear, and allows for better gas mileage. Also, it has a low thermal expansion coefficient that minimizes heat damage from pressure changes.

The GENTEC® Nitrogen Tire Inflation Kits include a 12" hose whip end, high pressure nitrogen regulator, dial pressure gauge with reset purge valve, and 12 ft. coiled hose. The kits are also available with 20 or 40 cu. ft. nitrogen cylinders in steel carrying stand.

Nitrogen Tire Inflation Kits

Model Number	Content
GKNT	• HQ14-012 12 FT. COILED PNEUMATIC HOSE
	• TW146 WHIP END
	• TF7000 INFLATION HANDLE
	• 452IN-175-WO NITROGEN REGULATOR
GKNT20-TC	• GKNT KIT
	• CY20-580 20 CU. FT. TANK, EMPTY
GKNT20-T	• CRT20N CYLINDER CARRYING STAND
	• GKNT KIT
GKNT40-TC	• CRT20N CYLINDER CARRYING STAND
	• GKNT KIT
	• CY40-580 40 CU. FT. TANK, EMPTY
GKNT40-T	• CRT40N CYLINDER CARRYING STAND
	• GKNT KIT



GKNT40-TC

Tire Kit Accessories



TW146

TF7000

HQ14-012

Model Number	Description
TW146	12" HOSE WITH WHIP END
452IN-175-WO	NITROGEN REGULATOR
TF7000	TIRE INFLATION HANDLE WITH GAUGE
HQ14-012	12FT. COILED PNEUMATIC HOSE
CRT20N	20 CU. FT. CYLINDER CARRYING STAND
CRT40N	40 CU. FT. CYLINDER CARRYING STAND
CY20-580	20 CU. FT. CYLINDER, EMPTY
CY40-580	40 CU. FT. CYLINDER, EMPTY

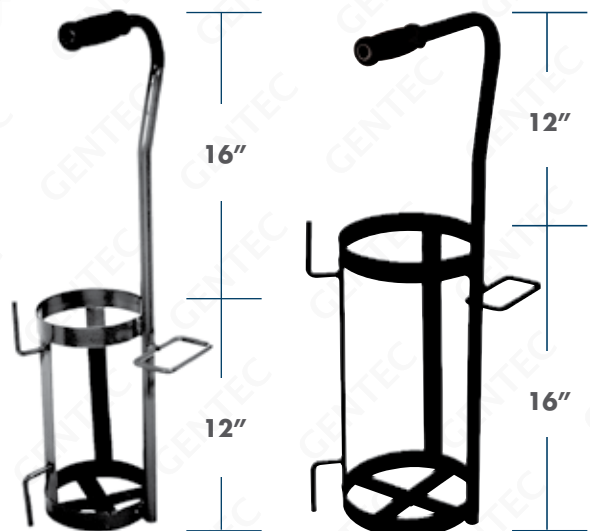

CRT20N

CRT40N

REGULATOR ACCESSORIES

Pressure Gauges

Industrial Gas Apparatus

GENTEC® Pressure Gauges are manufactured to meet strictly regulated quality standards (UL404 and ANSI/ASME B40.1) and provide accuracy & reliability for use in O.E.M. and replacement applications. GENTEC® brass gauges are offered in both single scale (PSI) and dual scale (PSI & kPa) to fulfill a wide variety of applications.

1-1/2" Steel Case, Dual Scale

1/8" NPT Inlet

Model Number	Scale Ranges	Entry Type	Case Color
G15-030RL	0-30 PSI RED	SIDE	RED
G15-100	0-100 PSI	SIDE	GREEN
G15-200	0-200 PSI	SIDE	GREEN
G15-400	0-400 PSI	SIDE	RED
GR15-3MEF	0-3000 PSI CONTENT	REAR	BLACK
GR15-3000RF	0-3000PSI CONTENT	REAR	BLACK
G15-4000	0-4000 PSI	SIDE	GREEN
GR15-4000		REAR	BLACK
GR15-4000G	0-4000 PSI	REAR	GOLD

2" Brass Case, Dual Scale

1/4" NPT Inlet

Model Number	Scale Ranges	Entry Type
G20B-030RL	0-30 PSI RED	SIDE
G20B-100	0-100 PSI	SIDE
G20B-200	0-200 PSI	SIDE
G20B-400	0-400 PSI	SIDE
G20B-600	0-600 PSI	SIDE
G20B-3000	0-3000 PSI	SIDE
G20B-4000	0-4000 PSI	SIDE

2-1/2" Brass Case, Dual Scale

1/4" NPT Inlet

Model Number	Scale Ranges	Entry Type
G25B-030RL	0-30 PSI RED	SIDE
G25B-60	0-60 PSI	SIDE
G25B-100	0-100 PSI	SIDE
G25B-200	0-200 PSI	SIDE
G25B-400	0-400 PSI	SIDE
G25B-600	0-600 PSI	SIDE
G25B-3000	0-3000 PSI	SIDE
G25B-4000	0-4000 PSI	SIDE
G25B-6000	0-6000 PSI	SIDE

2" Steel Case, Dual Scale

1/4" NPT Inlet

Model Number	Scale Ranges	Entry Type	Case Color
G20-030RL	0-30 PSI RED	SIDE	GOLD
G20-050CF	0-50 SCFH	SIDE	GOLD
G20-060	0-60 PSI	SIDE	GOLD
G20-100	0-100 PSI	SIDE	GOLD
G20-200	0-200 PSI	SIDE	GOLD
G20-300	0-300 PSI	SIDE	GOLD
G20-400	0-400 PSI	SIDE	GOLD
G20-600	0-600 PSI	SIDE	GOLD
G20-1500	0-1500 PSI	SIDE	GOLD
G20-3000	0-3000 PSI	SIDE	GOLD
G20-4000	0-4000 PSI	SIDE	GOLD
G20-6000	0-6000 PSI	SIDE	GOLD

2" Brass Case, Single Scale

1/4" NPT Inlet

Model Number	Scale Ranges	Entry Type
G20B-F030R	0-30 PSI RED	SIDE
G20B-F100	0-100 PSI	SIDE
GR20B-F100		REAR
G20B-F200	0-200 PSI	SIDE
GR20B-F200		REAR
G20B-F400	0-400 PSI	SIDE
GR20B-F400		REAR
GR20B-F600	0-600 PSI	REAR
G20B-F4000	0-4000 PSI	SIDE

2-1/2" Brass Case, Single

Scale 1/4" NPT Inlet

Model Number	Scale Ranges	Entry Type
G25B-F030R	0-30 PSI RED	SIDE
G25B-F100	0-100 PSI	SIDE
G25B-F200	0-200 PSI	SIDE
G25B-F400	0-400 PSI	SIDE
G25B-F600	0-600 PSI	SIDE
G25B-F4000	0-4000 PSI	SIDE

Replacement Plastic Lens

Model Number	Description
GX15	1-1/2" SNAP-ON
GX20	2" TWIST-LOCK
GX25	2-1/2" TWIST-LOCK



G15-4000



G20B-200



G20B-F4000



G25B-4000



G25B-F4000



GENTEC® Gauge Protectors are designed for Industrial Gas Regulators to reduce potential damages to pressure gauges

- Made with durable steel construction except for GP20X and GP20Y models, which are made with durable rubber
- Color coded: green for oxygen regulators and red for fuel gas regulators
- Powder-coated finish for steel models
- Regulator is not included but can also be ordered with a gauge protector attached (see items listed below)

NOTE: Gauge Protectors are not designed to replace or alleviate the need for proper cylinder storage systems. Cylinders should always be used and stored in conjunction with local and OSHA requirements. Consult with your Safety Department or Cylinder Gas supplier for additional information.

Model Number	Gas	Color	Fit Regulator*	Regulator w/ Gauge Protector
GP20X	OXYGEN	GREEN	210X-80	210X-80G
GP20Y	ACETYLENE	RED	210Y-15	210Y-15G
GP21X	OXYGEN	GREEN	152X-80	152X-80G
			152TX-80	152TX-80G
			752X-80	752X-80G
GP21Y	ACETYLENE	RED	152Y-15	152Y-15G
			152Y-15-3	152Y-15-3G
			152Y-15-5	152Y-15-5G
			152TY-15	152TY-15G
			152TY-15-3	152TY-15-3G
			752Y-15	752Y-15G
			752TY-15	752TY-15G
GP31X	OXYGEN	GREEN	153X-125	153X-125G
			153TX-125	153TX-125G
GP31Y	ACETYLENE	RED	153Y-15	153Y-15G
			153Y-15-3	153Y-15-3G
			153TY-15	153TY-15G
			153TY-15-3	153TY-15-3G

*Please refer to GENTEC® SILVER SERIES GAS WELDING & CUTTING APPARATUS brochure (Catalog No. BR-SILVER2008) for information of 752 and 753 series regulators

REGULATOR ACCESSORIES

Inlets, Nuts & Nipples

Industrial Gas Apparatus

GENTEC® Regulator Inlets, Outlets, and Accessories are accurately machined, with high quality brass, to meet CGA specifications. All inlet stems have a 45 micron sintered bronze filter installed and are interchangeable with all manufacturers' regulators that have 1/4" NPT port sizes. Remove "SF" from model number for ordering inlet stems without filter. For CGA 200, use filter model number R210-56 and for all other CGA connections, use R110-56.

CGA200	CGA300	CGA320
<p>FOR "MC" TANK ACETYLENE UP TO 500PSI 1/8" NPT</p> <p>NUT RNT305-2 1-1/4" NIPPLE/FILTER RNP305-3ASF</p>	<p>FOR COMMERCIAL ACETYLENE UP TO 500PSI 1/4" NPT</p> <p>NUT RNT16-2 3" NIPPLE/FILTER RNP16-8SF</p>	<p>FOR CARBON DIOXIDE UP TO 3000PSI 1/4" NPT</p> <p>NUT RNTCO2 WASHER RNP505 (FIBER) RNP506N (NYLON) 2" NIPPLE/FILTER RNP503-SF</p>
CGA346	CGA347	CGA350
<p>FOR AIR UP TO 3000PSI 1/4" NPT</p> <p>NUT RNT14-2 3" NIPPLE/FILTER RNP14-3SF</p>	<p>FOR "AIR/HIGH PRESSURE UP TO 5500PSI 1/4" NPT</p> <p>NUT RNT347-2 3" NIPPLE/FILTER RNP347-3SF</p>	<p>FOR "HYDROGEN/NATURAL GAS UP TO 3000PSI 1/4" NPT</p> <p>NUT RNT82 2-1/2" NIPPLE/FILTER RNP83SF</p>
CGA510	CGA520	CGA540
<p>FOR POL ACETYLENE & PROPANE UP TO 500PSI 1/4" NPT</p> <p>NUT RNT15-2 3" NIPPLE/FILTER RNP15-3SF</p>	<p>FOR "B" TANK ACETYLENE UP TO 500PSI 1/4" NPT</p> <p>NUT RNT300-2 1-3/4" NIPPLE/FILTER RNP300-3SF</p>	<p>FOR OXYGEN UP TO 3000PSI 1/4" NPT</p> <p>HAND TIGHT NUT 24-0662P NUT RNT62 NIPPLE/FILTER RNP66-SF(2-1/2") RNP61-SF(1-5/8")</p>
CGA580	CGA590	
<p>FOR INERT GAS, ARGON, HELIUM & NITROGEN UP TO 3000PSI</p> <p>NUT RNT92 WRENCH & HAND TIGHT NUT RNT92-HT HAND TIGHT NUT 24-0692P NIPPLE W/FILTER RNP15-3SF (3") RNP15-23SF (2-1/8") NIPPLE W/FILTER & O-RING RNP615-3SF (3-1/2") RNP615-25SF (2-3/8") O-RING RNPOR-11</p>	<p>FOR INDUSTRIAL AIR UP TO 3000PSI 1/4" NPT</p> <p>NUT RNT93 3" NIPPLE/FILTER RNP15-3SF</p>	
	CGA680	
	<p>FOR INERT GAS/HIGH PRESSURE UP TO 5500PSI 1/4" NPT</p> <p>NUT RNT680-2 3" NIPPLE/FILTER RNP680-3SF</p>	

ACETYLENE TO ACETYLENE



24-0015

Cylinder cga 510 "POL"
Regulator cga 300 "comm"
reference No: 15

ACETYLENE TO ACETYLENE



24-0016

Cylinder cga 300 "comm"
Regulator cga 510 "pol"
reference No: 16

ACETYLENE TO ACETYLENE



24-0051

Cylinder cga 510 "POL"
Regulator cga 300 "comm"
reference No: 51

ACETYLENE TO ACETYLENE



24-0061

Cylinder cga 300 "comm"
Regulator cga 510 "POL"
reference No: 61

ACETYLENE TO ACETYLENE



24-0306

Cylinder cga 520 "b"
Regulator cga 200 "mc"
reference No: 306



24-0314

Cylinder cga 200 "mc"
Regulator cga 520 "B"
reference No: 314

ACETYLENE TO ACETYLENE



24-0315

Cylinder cga 510 "POL"
Regulator cga 520 "b"
reference No: 315

ACETYLENE TO ACETYLENE



24-0317

Cylinder cga 520 "B"
Regulator cga 510 "pol"
reference No: 317

ACETYLENE TO ACETYLENE



24-0318

Cylinder cga 520 "b"
Regulator cga 510 "pol"
reference 318

ACETYLENE TO ACETYLENE



24-0319

Cylinder cga 520 "B"
Regulator cga 300 "comm"
reference No: 319

ACETYLENE TO ACETYLENE



24-0321

Cylinder cga 200 "mc"
Regulator cga 510 "pol"
reference No: 321

INERT GAS TO OXYGEN



24-0415

Cylinder cga 580
Regulator cga 540
reference No: 415

CO₂ TO INERT GAS



24-0806

Cylinder cga 320
Regulator cga 580
reference No: 806

INERT GAS TO CO₂



24-0810

Cylinder cga 580
Regulator cga 320
reference No: 810

ACETYLENE TO ACETYLENE



24-1690









Cylinder cga 300 "comm"
Regulator cga 510 "POL"
reference No: 1690





SELECTION TABLE		
From Cylinder Service	To Regulator Service	Model Number
CGA 200 "MC" ACETYLENE	CGA 510 "POL" ACETYLENE 90°	24-0321
CGA 200 "MC" ACETYLENE	CGA 520 "B" ACETYLENE	24-0314
CGA 300 "COMM" ACETYLENE	CGA 510 "POL" ACETYLENE 90°	24-1690
CGA 300 "COMM" ACETYLENE	CGA 510 "POL" ACETYLENE	24-0016
CGA 300 "COMM" ACETYLENE	CGA 510 "POL" ACETYLENE 1 PIECE	24-0061
CGA 320 CARBON DIOXIDE	CGA 580 INERT GAS	24-0806
CGA 510 "POL" ACETYLENE	CGA 300 "COMM" ACETYLENE	24-0015
CGA 510 "POL" ACETYLENE	CGA 300 "COMM" ACETYLENE 1 PIECE	24-0051
CGA 510 "POL" ACETYLENE	CGA 520 "B" ACETYLENE	24-0315
CGA 520 "B" ACETYLENE	CGA 300 "COMM" ACETYLENE	24-0319
CGA 520 "B" ACETYLENE	CGA 200 "MC" ACETYLENE	24-0306
CGA 520 "B" ACETYLENE	CGA 510 "POL" ACETYLENE	24-0317
CGA 520 "B" ACETYLENE	CGA 510 "POL" ACETYLENE 90°	24-0318
CGA 580 INERT GAS	CGA 320 CARBON DIOXIDE	24-0810
CGA 580 INERT GAS	CGA 540 OXYGEN	24-0415

REGULATOR ACCESSORIES





Outlets & Check Valves, Shut-Off Valve, Y Connection & Inert Arc Fittings

Industrial Gas Apparatus





CGA REGULATOR OUTLET BUSHING		
Oxygen "B" Size	Acetylene "B" Size	Inert Gas
9/16"-18 RH x 1/4" NPT  ROB32	9/16"-18 LH x 1/4" NPT  ROB33	5/8" - 18 RH x 1/4" NPT (0.032 ORIFICE)  ROB34
Oxygen "A" Size	Acetylene "A" Size	S.A.E. Flared
3/8"- 24 RH x 1/4" NPT  ROB134	3/8"- 24 LH x 1/4" NPT  ROB135	1/4" - 45° FLARE x 1/4" NPT  ROB48F
Barbed 3/16"	Barbed 3/8"	Push-In Tube
3/16" BARB x 1/4" NPT  ROB316	3/8" BARB x 1/4" NPT  R231-12	5/32" x 1/4" NPT  ROB532

REGULATOR CHECK VALVES	
Regulator Bushing Check Valve	Regulator Bushing Adapter Check Valve
PAIR 24-CV8PR  OXYGEN 24-CV8RO  Fuel 24-CV8rf	PAIR 24-CV9PR  OXYGEN 24-CV9RO  Fuel 24-CV9RF

ADJUSTING SCREWS
Locking Adjusting Screws
 For 190 Series R195-03  For 452 Series R230-03

BRASS SHUT-OFF VALVES			
Oxygen	Oxygen	Acetylene / Propane	Inert Gas
INLET 9/16"-18(RH) OUTLET 9/16"-18(RH)  24-0203	INLET 1/4" NPT OUTLET 9/16"-18(RH)  24-0205	INLET 1/4" NPT OUTLET 9/16"-18(LH)  24-0206	INLET 1/4" NPT OUTLET 5/8"-18(RH)  24-0215-AR

TEE COUPLERS	
Oxygen (CGA 540)	Inert Gas (CGA 580)
 24-T-62	 24-T-92

INERT ARC FITTINGS				
Nut	Nipple	Adapter	Hose Coupler RH	Hose Coupler LH
5/8"-18(RH)  24-AW-14A	1/4" ID HOSE  24-AW-17	5/8"-18(RH) x 1/4" NPT  24-AW-15A	5/8"-18(RH)  24-AW-430	5/8"-18(LH)  24-AW-431

Y CONNECTION / VALVES				
Oxygen	Acetylene	Oxygen / Valves	Acetylene / Valves	Inert Gas / Valves
INLET 9/16"-18(RH) OUTLET 9/16"-18(RH)  24-0101	INLET 9/16"-18(LH) OUTLET 9/16"-18(LH)  24-0102	INLET 9/16"-18(RH) OUTLET 9/16"-18(RH)  24-0111	INLET 9/16"-18(LH) OUTLET 9/16"-18(LH)  24-0112	INLET 5/8"-18(RH) OUTLET 5/8"-18(RH)  24-0411



GENTEC® Hose Repair Kits are designed and outfitted to allow timely hose repair in the shop or in the field. A tough polyethylene case holds the components: Hose nuts and nipples (A & B sizes), splicers, couplers, and various size ferrules most commonly used on 3/16" and 1/4" hose. Kits are equipped with 2 types of tools (see below). A display card with the fitting numbers and the compartment location is on case lid for added convenience in selecting and reordering.

KITS WITH "A" AND "B" TYPE FITTING FOR 3/16" AND 1/4" ID HOSES - ITEM NUMBERS INCLUDED IN KITS																		
Model Number	#C-1	#C-5	#7	#8	#9	#10	#17	#18	#19	#30	#31	#44	#45	#130	#131	#769	#7325	7326
CK-15P	1	--	8	8	4	4	10	6	8	1	1	4	2	1	1	12	10	10
CK-55P	--	1	8	8	4	4	10	6	8	1	1	4	2	1	1	12	10	10

KITS WITH "B" TYPE FITTING FOR 3/16" AND 1/4" ID HOSES - ITEM NUMBERS INCLUDED IN KITS														
Model Number	#C-1	#C-5	#7	#8	#17	#18	#30	#31	#44	#45	#769	#4750	#7325	#7326
CK-20SP	1	--	6	6	6	6	2	2	4	4	8	6	6	8
CK-24SP	--	1	6	6	6	6	2	2	4	4	8	6	6	8

KITS WITH "B" TYPE FITTING FOR 1/4" ID HOSE - ITEM NUMBERS INCLUDED IN KITS													
Model Number	#C-1	#C-5	#7	#8	#17	#30	#31	#44	#3588	#7325	#7326	#9940-P	
CK-22SP	1	--	6	6	12	2	2	4	6	4	12	3	
CK-26SP	--	1	6	6	12	2	2	4	6	4	12	3	

Kit Box (empty), CK-0, is available.

Crimping Tools



C-1



C-5

GENTEC® Crimping Tools are ideal for shop and field repair of hoses. They are made from high alloy and nickel-plated steel. A one-piece forged jaw provides superior strength.

Model Number	Description
C-1	3/16", 1/4" HAMMER OR VISE TYPE
C-5	3/16", 1/4" V-GRIP PLIER TYPE

HOSE ACCESSORIES

Hose Fittings, Couplers, Splicers, Adapters, Ferrules & Braces

Industrial Gas Apparatus

Hose Fittings, Ferrules & Braces are manufactured with high quality brass and accurately machined to meet CGA specifications.

Ferrules and braces are stamped from brass. The part number is stamped on each ferrule and brace for easy identification.

Brass Hose Nuts, Nipples, Couplers & Splicers, Pressure Up To 200 PSI

"A" Size Nuts	"A" Size Nipple	"A" Size Couplers	Hose Splicers
<p>3/8"-24 UNF-28</p>  <p>OXYGEN, RH 24-0009</p>  <p>FUEL, LH 24-0010</p>	 <p>3/16" I.D. Hose 24-0019</p>	<p>3/8"-24 UNF-28</p>  <p>OXYGEN, RH 24-0130</p>  <p>FUEL, LH 24-0131</p>	 <p>3/16" I.D. HOSE -3/16" I.D. HOSE 24-0045</p>  <p>1/4" I.D. HOSE -1/4" I.D. HOSE 24-0044</p>
"B" Size Nuts	"B" Size Nipples	"B" Size Couplers	"B" To "A" Hose Adapters
<p>9/16"-18 UNF-28</p>  <p>OXYGEN, RH 24-0007</p>  <p>FUEL, LH 24-0008</p>	 <p>3/16" - I.D. HOSE 24-0018</p>  <p>1/4" - I.D. HOSE 24-0017</p>	<p>9/16"-18 RH UNF-2B</p>  <p>OXYGEN, RH 24-0030</p>  <p>FUEL, LH 24-0031</p>	 <p>B Size (M) - A Size (F) RH 24-0105</p>  <p>B Size (M) - A Size (F) LH 24-0106</p>

Hose Ferrules



Model Number	Ferrule I.D.	Ferrule Length
24-0769	.450"	9/16"
24-3588	.564"	3/4"
24-4750	.478"	11/16"
24-7322	.500"	1"
24-7323	.525"	1"
24-7325	.562"	1"

Model Number	Ferrule I.D.	Ferrule Length
24-7326	.593"	1"
24-7327	.625"	1"
24-7328	.656"	1"
24-7329	.687"	1"
24-7330	.718"	1"

Hose Braces



Order Number	Description
24-9116	FOR 3/16" TWIN HOSES
24-9940P	FOR 1/4" TWIN HOSES

Tip Cleaners

GENTEC® “Wire-O” Tip Cleaner Sets feature blue anodized aluminum cover and stainless steel wire tapered ends for easy entry and uniform ridges for optimum cleaning. “Wire-O” standard size cleaners are 5/8” longer for more efficient cleaning of longer channels. “Wire-O” cleaners are excellent for cleaning clogged orifices in sprinklers, shower heads, gas range burners, and windshield washers, etc.



25-120



25-121



25-122



25-130

Model Number	Description	Number of Wires	Wire Length	Wire Sizes	Drill Sizes
25-120	STANDARD	13	2-3/4"	6-26	77-49
25-121	MASTER	21	2-3/4"	1-21	77-49
25-122	JUMBO	9	2-3/4"	13-21	77-49
25-130	KING SIZE	13	4-1/2"	6-26	77-49

Cylinder Wrenches

GENTEC® Cylinder Wrenches are drop forged, special alloy steel for maximum durability. Their “Baked” black powder-coated finish prevents rusting and enhances their appearance. The No. 5 “B” MC Key, is cadmium-plated (silver in color), and also prevents rusting.



27-1013



27-1013L



27-0005

Model Number	Description	Equivalent Number
27-1013	TEN MOUTH; 10 WAY CGA WRENCH W/SOCKET FOR COMMERCIAL ACETYLENE: 3/8" SOCKET (ACTUAL .390)	A-1013
27-1013L	NINE MOUTH; 9 WAY CGA WRENCH FOR NON-FUEL GAS & LINDE TYPE ACETYLENE GAS USERS	N/A
27-0005	B-KEY; 3-1/8" LONG BOX WRENCH FOR B & MC CYLINDERS; 3/16" BOX (ACTUAL .194), CADMIUM-PLATED	5

Welding Hoses, 9/16"-18 B Fitting

Model Number	Hose I.D.	Hose Length	Grade
HA14-006IN	1/4"	6'	-
HW23-012	3/16"	12.5'	R
HW23-T015	3/16"	15'	T
HW23-T020	3/16"	20'	T
HW24-T020	1/4"	20'	T
HW24-T025	1/4"	25'	T
HW24-050	1/4"	50'	R



HA14-006IN



HW23-T020

Welding Goggles & Cup Goggles



WELDING GOGGLES
9-WG1P



FIXED FRONT
WELDING GOGGLES
20-1775-5



FIXED FRONT
CUP STYLE GOGGLES
20-1675-5



CUP GOGGLES
9-WG6G



LIFT FRONT
WELDING GOGGLES
20-1710-5



LIFT FRONT
CUP STYLE GOGGLES
20-1610-5

Strikers



SINGLE FLINT SPARK LIGHTER
25-300



Triple FLINT SPARK LIGHTER
25-450

TECHNICAL DATA

Welding, Heating & Brazing Nozzles

Industrial Gas Apparatus

Welding Nozzles

171W, 172W, 173W, 173WRTE					
Tip Size	Metal Thickness	Drill Size	Oxygen (PSIG)	Acetylene (PSIG)	Acetylene (SCFH)
000	UP TO 1/32"	75 (.022)	3/5	3/5	1/2
00	1/16" - 3/64"	70 (.028)	3/5	3/5	1.5/3
0	1/32" - 5/64"	65 (.035)	3/5	3/5	2/4
1	3/64" - 3/32"	60 (.040)	3/5	3/5	3/6
2	1/16" - 1/8"	56 (.046)	3/5	3/5	5/10
3	1/8" - 3/16"	53 (.060)	4/7	3/5	8/18
4	3/16" - 1/4"	49 (.073)	5/10	4/7	10/25
5	1/4" - 1/2"	43 (.089)	6/12	5/8	15/35
6	1/2" - 3/4"	36 (.106)	7/14	6/9	25/45

472W			
Tip Size	Metal Thickness	Oxygen (PSIG)	Acetylene (PSIG)
0	1/64"	1	1
1	1/32"	1	1
2	3/64"	2	2
3	1/16"	3	3
4	3/32"	4	4
5	1/8"	5	5
6	3/16"	6	6
7	1/4"	7	7
8	5/16"	8	8

Mini-Style Oxy-Acetylene Brazing Tips

Model Number	Oxygen (PSIG)	Acetylene (PSIG)	Acetylene (SCFH)	Brazing Capacity For Copper	Welding Metal Thickness
GMTW-1	5	5	2/3	1/2"	3/64"
GMTW-2	5	5	2/4	1"	5/64"
GMIT	5	5	4/6	1"	N/A
GMTR	5	5	4/8	1-1/2"	N/A

Oxy-Acetylene Brazing Tips

Model Number	Oxygen (PSIG)	Acetylene (PSIG)	Acetylene (SCFH)	Brazing Capacity For Copper
G17-VMA-1	15	12	30	1/2" - 6"
G17-FT	5	5	4	UP TO 7/8"
G13-8VM	25	15	60	4" - 12"

Heating Nozzle Data

Model Number	Tip Size	Oxygen (PSIG)	Acetylene/Fuel (PSIG)	Oxygen (SCFH)	Acetylene/Fuel (SCFH)
171H / 172H / 173H	2	4/8	4/8	3/10	3/9
	4	8/12	6/10	7/22	6/20
	6	10/15	8/12	15/44	14/40
	8	20/30	10/15	33/88	30/80
	10	30/40	12/15	44/110	40/100
	12	50/60	12/15	66/165	60/150
171HN / 172HN / 173HN	15	50/60	12/15	99/244	90/220
	6	8/20	2/10	20/80	5.5/20
	8	10/20	10/15	40/140	10/35
	10	10/30	12/20	80/320	20/80
	12	30/25	15/25	120/640	30/160
	15	30/125	15/25	200/800	50/200
175HN	20	40/135	15/25	300/1000	75/250
	10	70/100	15/25	150/200	150/200
	15	90/120	20/35	250/350	250/350
472H-2	2	3/7	3/7	N/A	30/50

*173H-12 and 173H-15 are also used for propylene based fuel gases and MAPP®

172C & 173C Oxy-Acetylene Cutting Tips

Tip Size	Metal Thickness	Cutting Speed (IN/MIN)	Cutting Oxygen (PSIG)	Cutting Oxygen (SCFH)	Pre-Heat Oxygen (PSIG *)	Pre-Heat Oxygen (SCFH)	Acetylene (PSIG)	Acetylene (SCFH)
000	1/8"	28/30	20/25	20/25	3/5	3/5	3/5	3/5
00	1/4"	27/30	20/25	30/35	3/5	4/6	3/5	4/6
0	3/8"	24/28	25/30	55/60	3/5	5/9	3/5	5/8
0	1/2"	20/24	30/35	60/65	3/6	7/11	3/5	6/10
1	3/4"	17/21	30/35	80/85	4/7	9/14	3/5	8/10
2	1"	15/19	35/40	140/150	4/9	11/18	3/6	10/16
2	1-1/2"	13/17	40/45	150/160	4/12	13/20	3/7	12/18
3	2"	12/15	40/45	210/225	5/14	15/24	4/9	14/22
3	2-1/2"	10/13	45/50	225/240	5/16	18/29	4/10	16/26
4	3"	9/12	45/50	270/320	6/17	20/33	5/10	18/30
5	4"	8/11	45/55	390/450	7/18	24/37	5/12	22/34
5	5"	7/9	50/55	425/450	7/20	29/41	5/13	26/38
6	6"	6/8	45/55	500/600	10/22	33/48	7/13	30/44
6	8"	5/6	45/55	500/600	10/25	37/55	7/14	34/50
7	10"	4/5	45/55	700/850	15/30	44/62	10/15	40/56
8	12"	3/5	45/55	900/1000	20/35	53/88	10/15	48/62

172CN & 173CN Oxy-Propane / Natural Gas Cutting Tips

Tip Size	Metal Thickness	Cutting Speed (IN/MIN)	Cutting Oxygen (PSIG)	Cutting Oxygen (SCFH)	Pre-Heat Oxygen (PSIG *)	Pre-Heat Oxygen (SCFH)	Fuel Gas (PSIG)	Fuel Gas (SCFH)
000	1/8"	24/28	20/25	12/14	20/25	23/108	3/5	5/6
00	1/4"	21/25	20/25	22/26	20/25	23/108	3/5	5/7
0	3/8"	20/24	25/30	45/55	20/25	23/108	3/5	8/10
0	1/2"	18/22	30/35	50/55	20/25	23/108	3/5	8/10
1	3/4"	15/20	30/35	70/80	20/25	23/108	4/6	10/12
2	1"	14/18	35/40	115/125	20/25	23/108	4/8	12/15
2	1-1/2"	12/16	40/45	125/135	20/25	23/108	5/9	12/15
3	2"	10/14	40/50	105/175	20/25	23/108	5/9	14/18
3	2-1/2"	9/12	45/50	175/200	20/25	23/108	6/10	14/18
4	3"	8/11	45/50	210/250	20/25	23/108	8/12	16/20
5	4"	7/10	54/55	300/360	20/25	23/108	8/12	20/30
5	5"	6/9	50/55	300/360	20/25	23/108	8/12	20/30
6	6"	5/7	45/55	400/500	20/25	38/153	10/15	25/35
6	8"	4/6	55/65	450/500	20/25	38/153	10/15	25/35

*Only applicable for three-hose machine torches

TECHNICAL DATA

Cutting Tips 172 & 173 Series

Industrial Gas Apparatus

172CP & 173CP & 173CM Oxy-Propane / MAPP Cutting Tips

Tip Size	Metal Thickness	Cutting Speed (IN/MIN)	Cutting Oxygen (PSIG)	Cutting Oxygen (SCFH)	Pre-Heat Oxygen (PSIG*)	Pre-Heat Oxygen (SCFH)	Acetylene (PSIG)	Acetylene (SCFH)
00	1/4"	21/25	20/25	22/26	20/25	23/108	3/5	5/7
0	3/8"	20/24	25/30	45/55	20/25	23/108	3/5	8/10
0	1/2"	18/22	30/35	50/55	20/25	23/108	3/5	8/10
1	3/4"	15/20	30/35	70/80	20/25	23/108	4/6	10/12
2	1"	14/18	35/40	115/125	20/25	23/108	4/8	12/15
2	1-1/2"	12/16	40/45	125/135	20/25	23/108	5/9	14/18
3	2"	10/14	40/45	105/175	20/25	23/108	5/9	14/18
3	2-1/2"	9/12	45/50	175/200	20/25	23/108	6/10	14/18
4	3"	8/11	45/50	210/250	20/25	23/108	8/12	16/20
5	4"	7/10	45/50	300/360	20/25	23/108	8/12	20/30
5	5"	6/9	50/55	300/360	20/25	23/108	8/12	20/30

173CHP Oxy-Propylene / MAPP High Speed Cutting Tips

173CHN Oxy-Propane / Natural Gas High Speed Cutting Tips

Tip Size	Metal Thickness	Cutting Speed (IN/MIN)	Cutting Oxygen (PSIG)	Cutting Oxygen (SCFH)	Pre-Heat Oxygen (PSIG*)	Pre-Heat Oxygen (SCFH)	Fuel Gas (PSIG)	Fuel Gas (SCFH)
00	1/4"	22/33	85/100	68/75	10/15	23/140	5 UP	12/65
00	3/8"	22/31	85/100	68/75	10/15	23/140	5 UP	12/65
0	1/2"	20/30	85/100	110/120	10/15	23/140	5 UP	12/65
0	3/4"	18/28	85/100	110/120	10/15	23/140	5 UP	12/65
1	1"	17/27	85/100	145/160	10/15	23/140	5 UP	12/65
1	1-1/4"	16/23	85/100	145/160	10/15	23/140	5 UP	12/65
1	1-1/4"	12/19	85/100	145/160	10/15	23/140	5 UP	12/65
2	2"	11/17	85/100	230/250	10/15	23/140	5 UP	12/65
2	2-1/2"	10/15	85/100	230/250	10/15	23/140	5 UP	12/65
2	3"	9/13	85/100	230/250	10/15	23/140	5 UP	12/65
3	4"	7/11	85/100	285/320	10/15	23/140	5 UP	12/65
3	5"	6/9	85/100	285/320	10/15	23/140	5 UP	12/65
3	6"	5/8	85/100	285/320	10/15	23/140	5 UP	12/65
4	7"	5/7	85/100	390/450	10/15	23/140	5 UP	12/65
4	8"	4/7	85/100	390/450	10/15	23/140	5 UP	12/65
5	9"	4/6	85/100	670/720	10/15	23/140	5 UP	12/65
5	10"	3/6	85/100	670/720	10/15	23/140	5 UP	12/65

*Only applicable for three-hose machine torches

472C Oxy-Acetylene Cutting Tips

Tip Size	Metal Thickness	Oxygen (PSIG)	Fuel Gas (PSIG)
000	0 to 3/16"	15/20	5/15
00	3/16"- 3/8"	20/25	5/15
0	3/8"- 5/8"	35/40	5/15
1	5/8"- 1"	35/40	5/15
2	1"- 2"	40/45	5/15
3	2"- 3"	45/50	5/15
4	3"- 6"	50/75	10/15

472CN Oxy-Propane/Natural Gas Cutting Tips

Tip Size	Metal Thickness	Oxygen (PSIG)	Fuel Gas (PSIG)
000	0 to 3/16"	15/30	5/15
00	3/16"- 3/8"	20/30	5/15
0	3/8"- 5/8"	30/40	5/15
1	5/8"- 1"	35/50	5/15
2	1"- 2"	40/55	5/15
3	2"- 3"	45/60	5/15
4	3"- 6"	50/75	5/15
5	6"- 8"	65/80	5/15
6	8"- 12"	70/90	5/15

473CHN Oxy-Propane/Natural Gas High Speed Cutting Tips

Tip Size	Metal Thickness	Cutting Speed (IN/MIN)	Cutting Oxygen (PSIG)	Cutting Oxygen (SCFH)	Pre-Heat Oxygen (PSIG *)	Pre-Heat Oxygen (SCFH)	Fuel Gas (PSIG)	Propane (SCFH)	Natural Gas (SCFH)
0	3/4"	15	90	125	10/35	35	2	7	18
1	2"	13	100	200	12/35	40	2	8	20
2	4"	7	100	325	12/35	40	2	8	20
3	6"	5	100	425	12/40	40	2	8	20
4	8"	5	100	525	12/40	40	2	8	20
5	9"	4	90	580	40	100	2	20	50
6	11"	4	60	690	40	100	2	20	50
7	12"	4	60	825	40	100	2	20	50
8	15"	3	60	925	40	100	2	20	50

672C Oxy-Acetylene Cutting Tips

Tip Size	Metal Thickness	Cutting Speed (IN/MIN)	Oxygen (PSIG)	Oxygen (SCFH)	Acetylene (PSIG)	Acetylene (SCFH)
0	1/4"	20/24	30	57	2	14
1	3/8"	18/21	30	84	3	20
2	3/4"	14/17	40	134	3	22

Tip Size	Metal Thickness	Cutting Speed (IN/MIN)	Oxygen (PSIG)	Oxygen (SCFH)	Acetylene (PSIG)	Acetylene (SCFH)
0	5/16"	20/24	30	60	2	17
1	1/2"	17/20	40	105	3	25
2	1"	14/16	50	160	3	27

*Only applicable for three-hose machine torches

TECHNICAL DATA

Cutting Tips 672CHN, 672CHNP, 572C, 572CN Series

Industrial Gas Apparatus

672CHN Oxy-Natural Gas Cutting Tips

Tip Size	Metal Thickness	Cutting Speed (IN/MIN)	Cutting Oxygen (PSIG)	Pre-Heat Oxygen (PSIG *)	Fuel Gas (PSIG)
0	1/4"	29	100	30	2.1
0	3/8"	27	100	30	2.1
1	1/2"	25	100	40	2.1
2	3/4"	22	100	45	2.1
2	1"	20	100	45	2.1
3	1-1/2"	18	100	45	2.1
4	2"	16	100	45	2.1
5	2-1/2"	14	100	55	2.1
5	3"	12.5	100	55	2.1
6	4"	10	100	55	2.1
6	5"	9	100	55	2.1
7	6"	7	100	65	2.1
7	8"	5.5	100	65	2.1
8	10"	4	100	65	2.1
8	12"	3	100	65	2.1

673CHNP Oxy-Propane/Propylene Cutting Tips

Tip Size	Metal Thickness	Cutting Speed (IN/MIN)	Cutting Oxygen (PSIG)	Cutting Oxygen (SCFH)	Pre-Heat Oxygen (PSIG *)	Pre-Heat Oxygen (SCFH)	Fuel Gas (PSIG)	Fuel Gas (SCFH)
0	1/4"	26/30	100	25/40	30	40/45	2/5	10/12
0	3/8"	26/29	100	25/40	30	40/45	2/5	10/12
1	1/2"	23/27	100	80/90	40	40/45	2/5	10/12
2	3/4"	20/24	100	130/140	45	45/50	3/6	10/15
2	1"	18/22	100	130/140	45	45/50	3/6	10/15
3	1-1/2"	16/20	100	180/200	45	45/50	3/6	10/15
4	2"	14/18	100	250/270	45	65/70	3/6	15/20
5	2-1/2"	12/14	100	350/360	55	65/70	3/6	15/20
5	3"	10/15	100	350/370	55	65/70	3/6	15/20

572C Oxy-Acetylene Cutting Tips

Tip Size	Metal Thickness	Oxygen (PSIG)	Oxygen (SCFH)	Fuel Gas (PSIG)	Fuel Gas (SCFH)
0	1/4"	35	47	10	6
0	3/8"	40	55	10	6
1	1/2"	45	85	10	7
1	5/8"	50	90	10	7
2	3/4"	50	120	10	9
2	1"	55	130	10	9
3	1-1/2"	55	180	10	10
3	2"	60	195	10	10

572CN Oxy-Propane/Natural Gas Cutting Tips

Tip Size	Metal Thickness	Oxygen (PSIG)	Oxygen (SCFH)	Fuel Gas (PSIG)	Fuel Gas (SCFH)
1	1/2"	45	110	10	7
1	5/8"	50	115	10	7
2	3/4"	50	140	10	7
2	1"	55	155	10	7
2	1-1/4"	60	170	10	7

*Only applicable for three-hose machine torches

573C Oxy-Acetylene Gas Cutting Tips

Tip Size	Metal Thickness	Cutting Speed (IN/MIN)	Oxygen (PSIG)	Oxygen (SCFH)	Acetylene (PSIG)	Acetylene (SCFH)
1	1/2"	19	35	85	10	10
1	5/8"	17	40	100	10	10
2	3/4"	16	35	115	10	11
2	1"	14	40	130	10	11
2	1-1/4"	13	50	150	10	11

772C Oxy-Acetylene Gas Cutting Tips

Tip Size	Metal Thickness	Cutting Speed (IN/MIN)	Oxygen (PSIG)	Oxygen (SCFH)	Acetylene (PSIG)	Acetylene (SCFH)
2	5/8"	16/20	38/45	75/85	5/10	10/12
2	3/4"	14/18	23/28	95/100	5/10	12/14
2	1"	13/15	30/35	120/125	5/10	14/16
2	1-1/2"	11/13	45/56	165/175	5/10	16/20
4	2"	10/12	30/38	195/200	5/10	18/20
4	3"	9/11	40/48	230/240	5/10	18/22
4	4"	8/10	60/73	300/325	5/12	21/25
6	5"	7/9	58/62	350/380	7/12	20/25
6	6"	6/8	67/73	400/460	7/12	25/30

The Small Torch Tip

10STP OXY-FUEL TIPS			
Tip Size	Gas Service	Oxygen (PSIG)	Fuel Gas (PSIG)
2	ACETYLENE	2	2
3	ACETYLENE PROPANE MAPP® PROPYLENE	3	3
4		4	4
5		6	6
6		6	6
7		8	8

OXY-FUEL TWIN TIPS		
Model Number	Oxygen (PSIG)	Fuel Gas (PSIG)
10STP-3C	4	4
10STP-4C	4	4
10STP-5C	6	6

OXY-FUEL HEATING TIPS		
Model Number	Oxygen (PSIG)	Fuel Gas (PSIG)
10STP-HF6	14	10
10STP-HY6	14	10

The Compact Torch Tips

10CMP OXY-FUEL TIPS			
Tip Size	Gas Service	Oxygen (PSIG)	Fuel Gas (PSIG)
2	ACETYLENE	25	4
3	ACETYLENE PROPANE MAPP®	25	4
4		28	4.5
5		28	4.5
6		30	5
7		30	6

OXY-ACETYLENE TWIN TIP & HEATING TIPS				
Model Number	Oxygen (PSIG)	Fuel Gas (PSIG)	Fuel Gas (SCFH)	Brazing Capacity For Copper
10CMP-GMTT	5	5	4/6	1"
10CMP-GMTR	5	5	4/8	1-1/2"

INDEX & COMPARISON CHART

Welding & Cutting Apparatus Chart

Industrial Gas Apparatus

EQUIVALENT CODE KEY (C) CONCOA/AIRCO®; (CS) CUTSKILL®; (FP) FIREPOWER®; (H) HARRIS®; (K) Koike; (P) PUROX/ESAB® (S) Superior; (SM) Smith Equipment®; (U) UNIWELD®; (V) VICTOR® ; (W) Western Enterprise®								
Model Number	PP	Equivalent Number	Model Number	PP	Equivalent Number	Model Number	PP	Equivalent Number
10CM	29		140T-CV	8		152IN-125	36	(FP) FPR250-125-580
10CM-H12	29		140T-FA	8				(H) 2500-125-580
10CMP	30		141C	10	(U) CA250			(SM) H1730C-580
10CMP-C3SP	30				(V) CA1260			(V) SR250D-580
10CMP-C4SP	30		141T	8	(U) WH250	152LF-80	53	(V) L261C-250
10CMP-GMTR	30				(V) J100C	152LX-125	53	(U) RUHL8210
10CMP-GMTT	30		141TA	8				(V) L250D-250
10ST	26	(SM) 11-1101C	141TA-CV	8		152LX-200	53	
10ST-H06	26		141TA-FA	8		152LX-80	53	
10ST-H12	26		141T-CV	8		152LY-15	53	(U) RUHL8211
10STP	26	(SM) 12-1401	141T-FA	8				(V) L260A-250
		(U) ART(X)A	142C	10	(CS) CA270-V	152Q-125	36	(U) RUH8218
10STP-2~6SP	26				(FP) CA250-FS			(U) SR250D-346
10STP-3~7SP	26				(U) CA350			(W) RS-2-3
10STP-3C	26	(SM) 12-1402-03	142T	8	(V) CA1350	152Q-15	36	
		(U) ART3AT			(U) WH350	152SF-125	49	(V) S261D-025
10STP-4C	26	(SM) 12-1402-04	142T-CV	8	(V) 100C	152SF-80	49	(U) RUHS8212
		(U) ART4AT	142T-FA	8	(CS) WH270FC-V			(V) S261C-025
10STP-5C	26	(SM) 12-1402-05			(FP) WH270FC-FS	152SIN-125	49	(U) RUHS8214
		(U) ART5AT			(V) 100FC			(V) S250D-034
10STP-HF6	26	(SM) 13-662	143ACA	10	(U) 780	152SIN-40	49	(V) S250B-034
		(U) ART662			(V) 2461	152SIN-40FG	49	(V) SFG250-034
10STP-HY6	26	(SM) 13717	143CA	10	(CS) CA370-V	152SIN-80	49	(V) S250C-034
		(U) ART717			(FP) CA350-FS	152SX-125	49	(U) RUHS8210
1120	2				(U) 780A	152SX-40	49	(V) S250D-024
1120-3	2				(V) CA2460	152SX-80	49	(V) S250B-024
1120FA	2		143SCA	10	(U) 780B	152SY-15	49	(V) S250C-024
1120FA-3	2				(V) 2462			(U) RUHS8211
1121	2		143T	8	(U) WH360	152TF-80	45	(V) S260A-025
1121-3	2				(V) 315C			(U) RHT8012
1121FA	2	(V) Performer				152TIN-125	45	(V) VTS261B-510
1121FA-3	2	(V) Performer	143T-CV	8				(U) RHT8014
1130	4		143T-FA	8	(CS) WH370FC-V			(V) VTS250D-580
1130-3	4				(FP) WH370FC-FS	152TQ-125	45	(U) RHT8018
1130FA	4	(V) Journeyman			(V) 315FC			(V) VTS250D-346
1130FA-3	4	(V) Journeyman	143TL	8	(U) WH360L	152TX-80	45	(U) RHT8010
1131	4				(V) 310C			(V) VTS250C-540
1131-3	4		143TL-CV	8		152TX-80	75	
1131FA	4	(V) Journeyman II	143TL-FA	8		152TX-80G	45	
1131FA-3	4	(V) Journeyman II	143TLH	8	(U) 72L11	152TX-80G	75	
1138	3				(V) HD310C	152TY-15	45	(U) RHT8011
1138-3	3		143TLH-CV	8				(V) VTS260A-510
1138FA	3	(V) Contender	143TLH-FA	8		152TY-15	75	
1138FA-3	3	(V) Contender	152AR-100	61	(CS) AF200-580	152TY-15-3	45	(U) RHT8011-1
11ST	26				(H) 425-AR100-580			(V) VTS260A-300
1221	3				(U) RHFG14-50	152TY-15-3G	45	
1221-3	3				(W) RS-3-FG			
1221FA	3	(V) Super Range II	152CD-100	61	(H) 425-CD100-320	152TY-15G	45	
1221FA-3	3	(V) Super Range II			(SM) H1758-320			
12-PT	6	(U) KL350-P			(U) RHFG13-50	152X-125	36	(V) SR250D-540
		(V) Portable Torch	152F-80	36	(W) RS-4-FG	152X-125G	36	
		(U) KL350-P-TU			(CS) RC250-40-510LP	152X-80	36	(CS) RC250-80-540
		(V) Portable Torch			(FP) 250-40-510LP-FB			(FP) 250-80-540-FB
12-PTCSP	6				(H) 2500-50-510P			(SM) H1710C-540
13-OS	7				(SM) H1722C-510	152X-80G	36	(V) SR250C-540
13-OSA	7				(V) SR261C-510			
13-OSAFA	7	(V) Journeyman Select	152H-125	36	(V) SR252D-350			
13-OSFA	7	(U) KV780AFB	152H-15	36	(V) SR252A-350	152Y-15	36	(CS) RC250-15-510
		(V) Journeyman Select	152H-40	36	(V) SR252B-350			(FP) 250-15-510-FB
140T	8	(U) J1	152H-80	36	(V) SR252C-350			(H) 2500-15-510
		(V) J-28						(SM) H1721C-510
								(V) SR260A-510

CONCOA® & AIRCO® are registered trademarks of Controls Corps. of America.; FIREPOWER®, VICTOR® & CUTSKILL® are registered trademarks of Victor Equipment Company; HARRIS® is a registered trademark of The Lincoln Electric Company; PUROX® & ESAB® are registered trademarks of ESAB® Welding & Cutting Products; SMITH EQUIPMENT® is a registered trademark of Illinois Tool Works Inc.; UNIWELD® is a registered trademark of Uniweld Products Inc.; Western Enterprises® is a registered trademark of Scott & Fetzer Company. The above listed companies are not associated with Genstar Technologies Co., Inc.

EQUIVALENT CODE KEY (C) CONCOA/AIRCO®; (CS) CUTSKILL®; (FP) FIREPOWER®; (H) HARRIS®; (K) Koike; (P) PUROX/ESAB® (S) Superior; (SM) Smith Equipment®; (U) UNIWELD®; (V) VICTOR® ; (W) Western Enterprise®								
Model Number	PP	Equivalent Number	Model Number	PP	Equivalent Number	Model Number	PP	Equivalent Number
152Y-15-3	36	(CS) RC250-15-300	153TIN-125	46	(H) 9200-125-580	153Y-15-3	41	(CS) RC450-15-300
	75	(FP)250-15-300-FB (H) 2500-15-300 (SM) H1720C-300 (V) SR260A-300		46	(U) RVT8014 (V) VTS450D-580 (W) RD-7-3		75	(H) 3500-15-300 (SM) HB1520B-300 (U) RV8011-1 (V) SR460A-300 (W) RC-1A-1
152Y-15-3G	36		153TIN-250	46	(H) 9200-250-580 (SM) H1414B-580 (V) VTS450E-580 (W) RD-7-4	153Y-15-3G	41	
	75			46			75	
152Y-15-5	36	(V) SR260A-520	153TMX-125	57		153Y-15G	41	
	75			57			75	
152Y-15-5G	36		153TMY-15	57		153Y-15G	41	
	75			57			75	
152Y-15G	36		153TQ-125	46	(H) 9200-125-590 (V) VTS450D-590	153Y-15G	41	
	75			46	(H) 9200-160-346 (H) 9200-250-346 (U) RVT8018 (V) VTS450E-346		42	(V) SR711D-510 (V) SR702E-350
153C-125	41	(U) RV8013 (V) SR453D-320 (W) RC-4-3	153TQ-200	46	(H) 9200-160-346 (H) 9200-250-346 (U) RVT8018 (V) VTS450E-346	153Y-15G	42	
	41	(SM) HB1533-320 (V) SR453E-320 (H) 3500-50-510P (SM) HB1522B-510 (U) RV8012 (V) SR461D-510		46	(H) 9200-125-540 (SM) H1410B-540 (U) RVT8010 (V) VTS450D-540 (W) RD-9-3		43	
153C-200	41		153TX-125	46		153Y-15G	42	
	41			46			43	
153F-125	41		153TX-125G	46		153Y-15G	42	
	41			46			43	
153H-125	41		153TX-250	46	(SM) H1413B-540 (U) RVT8010-3 (V) VTS450E-540 (W) RD-9-4	153Y-15G	42	
	41			46			43	
153H-200	41		153TX-250	46		153Y-15G	42	
	41			46			43	
153IN-125	41	(CS) RC450-125-580 (H) 3500-125-580 (U) RV8014 (V) SR450D-580 (W) RC-7-3	153TY-15	46	(H) 9200NC-15-510 (SM) H1421B-510 (U) RVT8011 (V) VTS460A-510 (W) RD-1-1	153Y-15G	42	
	41			46			43	
153IN-250	41	(SM) HB1530-580 (V) SR450E-580 (W) RC-7-4	153TY-15-3	46	(H) 9200NC-15-300 (SM) H1420B-300 (U) RVT8011-1 (V) VTS460A-300 (W) RD-1A-1	153Y-15G	42	
	41			46			43	
153IN-250-F	41	(U) RV8015A-1	153TY-15-3G	46		153Y-15G	42	
	56	(H) 3510-125LH (V) SR461MD-997 (H) 3510-125RH (V) SR450MD-996 (W) RM-2-4		46			43	
153MF-125	56		153TY-15G	46		153Y-15G	42	
	56			46			43	
153MX-125	56		153TY-15G	46		153Y-15G	42	
	56			46			43	
153MX-200	56		153X-125	41	(CS) RC450-125-540 (H) 3500-125-540 (SM) HB1510A-540 (U) RV8010 (V) SR450D-540 (W) RC-9-3	153Y-15G	42	
	56			41			43	
153MY-15	56		153X-125G	41		153Y-15G	42	
	56			41			43	
153Q-125	41		153X-250	41	(H) 3500-200-540 (SM) HB1511A-540 (U) RV8010-3 (V) SR450E-540 (W) RC-9-4	153Y-15G	42	
	41			41			43	
153Q-200	41		153Y-15	41	(CS) RC450-15-510 (H) 3500-15-510 (SM) HB1521B-510 (U) RV8011 (V) SR460A-510 (W) RC-1-1	153Y-15G	42	
	41			41			43	
153TC-125	46		153Y-15	41		153Y-15G	42	
	46			41			43	
153TC-200	46		153Y-15	41		153Y-15G	42	
	46			41			43	
153TF-125	46		153Y-15	41		153Y-15G	42	
	46			41			43	

CONCOA® & AIRCO® are registered trademarks of Controls Corps. of America.; FIREPOWER®, VICTOR® & CUTSKILL® are registered trademarks of Victor Equipment Company; HARRIS® is a registered trademark of The Lincoln Electric Company; PUROX® & ESAB® are registered trademarks of ESAB® Welding & Cutting Products; SMITH EQUIPMENT® is a registered trademark of Illinois Tool Works Inc.; UNIWELD® is a registered trademark of Uniweld Products Inc.; Western Enterprises® is a registered trademark of Scott & Fetzer Company. The above listed companies are not associated with Genstar Technologies Co., Inc.

INDEX & COMPARISON CHART

Welding & Cutting Apparatus Chart

Industrial Gas Apparatus

EQUIVALENT CODE KEY (C) CONCOA/AIRCO®; (CS) CUTSKILL®; (FP) FIREPOWER®; (H) HARRIS®; (K) Koike; (P) PUROX/ESAB® (S) Superior; (SM) Smith Equipment®; (U) UNIWELD®; (V) VICTOR® ; (W) Western Enterprise®								
Model Number	PP	Equivalent Number	Model Number	PP	Equivalent Number	Model Number	PP	Equivalent Number
161S-17-FA	12	(U) EC72740AFB (V) CST800FC	171HN	20	(V) MFN-J	175HN	21	(V) Type 55
162L-21	12	(FP) ST900C-FS (V) ST900C	171W	17	(U) Type 17 (V) W-J	190AR1-50	60	
162L-21-CV	12		171W-000~0	30		190AR1-50-6HSP	66	
162L-21-FA	12	(V) ST900FC	172C	22	(FP) 3-101-FP (U) 3-101 (V) 3-101	190AR1-50-B	60	
162S-17	12	(V) SST900C	172CG	22	(U) 3-118 (V) 3-118	190AR1-50-P	60	
162S-17-CV	12		172CN	22	(FP) 3-GPN-FP (U) 3-GPN (V) 3-GPN	190AR-50	60	(CS) AF150-580 (FP) AF150-580-FB (H) 301-AR60-580 (SM) H1957B-580 (U) CEFG14 (V) AF250-580 (W) REB-3-FG
162S-17-FA	12	(V) SST900FC	172CP	22	(U) 3-GPP (V) 3-GPP	190AR-50-6HSP	66	(CS) AF150-580-CS (H) 301AR-58010 (SM) H1957B-580-H (W) REB-3-FGD
163AL-21	12	(V) ST1601C	172H	20	(FP) MFA-1-FS (U) TYPE 29 (V) MFA-1	190AR-50-B	60	
163AL-21-CV	12	(U) 831-21	172HN	20	(V) UN-1	190AR-50-P	60	
163AL-21-FA	12	(U) 831-21FB (V) ST2601FC (V) ST1611C	172W	17	(FP) W-1-FS (U) Type 13 (V) W-1	190C-175	34	(CS) SR5-40-320 (H) 301-100-320 (SM) H1933A-320 (V) SR5B-320 (W) REB-4-3 (U) R1363
163AL-27	12		172WRTE	18	(V) UN-1+TEN	190CD-45	60	(CS) CF153-320-FB (H) 301-CD60-320 (SM) H1958B-320 (U) CEFG13 (V) CF253-320 (W) REB-4-FG
163AL-27-CV	12	(V) ST2611FC	173C	22	(FP) 1-101-FP (U) 1-101 (V) 1-101	190CD-45-6HSP	66	(CS) CF153-320-CS (H) 301CD-32010 (SM) H1958B-320 (W) REB-4-FGD (U) MR8212 (V) SR7-40-510
163AL-27-FA	12	(V) ST1631C	173CG	22	(FP) 1-118-FP (U) 1-118 (V) 1-118	190F-80	34	(CS) SR7-40-510 (SM) H1945E-510 (U) MR8212 (V) SR7-40-510
163AL-36	12	(U) 831-36	173CGN	22	(U) 1-234 (V) 1-234	190H-80	34	(SM) H1931A-580 (U) R1563
163AL-36-CV	12	(U) 831-36FB (V) ST2631FC	173CHN	22	(U) MTHN (V) MTHN	190IN-175	34	(CS) SR5-40-580 (H) 301-100-580 (V) SR5B-580 (W) REB7-3
163AL-36-FA	12	(U) 831-36FB (V) ST2631FC	173CHP	22	(U) MTHP (V) MTHP	190IN-175-F	34	(CS) SR5-60-540 (FP) 150-60-540-FB (H) 301-100-540 (SM) H1910F-540 (U) MR8210 (V) SR5-60-540 (W) REB-9-3
163AL-48	12	(V) ST1651C	173CM	22	(U) GPM (V) GPM	190IN-80	34	(CS) SR6-15-510 (FP) 150-15-510-FB (H) 301-15-510 (SM) H1945E-510 (U) MR8211 (V) SR6-15-510 (W) REB-1-1
163AL-48-CV	12	(U) 831-48	173CN	22	(FP) GPN-FP (U) GPN (V) GPN	190Y-15	34	
163AL-48-FA	12	(U) 831-48FB (V) ST2651FC	173CP	22	(U) GPP (V) GPP			
163L-21	12	(V) ST1600C	173H	20	(FP) MFA-FS (U) TYPE 11 (V) MFA			
163L-21-CV	12	(U) 830-21	173HN	20	(U) Type 12 (V) MFN			
163L-21-FA	12	(U) 830-21FB (V) ST2600FC (V) ST1610C	173MFTA-10	14	(V) 10-1-MFTA			
163L-27	12		173MFTA-12	14	(V) 12-1-MFTA			
163L-27-CV	12		173MFTN-10	14	(V) 10-1-MFTN			
163L-27-FA	12	(V) ST2610FC	173MFTN-12	14	(V) 12-1-MFTN			
163L-36	12	(V) ST1630C	173W	17	(FP) W-FP (U) Type 4 (V) W			
163L-36-CV	12	(U) 830-36	173WRTE	18	(U) Type 1 (V) RTE			
163L-36-FA	12	(U) 830-36FB (V) ST2630FC	173WRTE	18	(V) RTEN			
163L-48	12	(V) ST1650C	173WRTE	18				
163L-48-CV	12	(U) 830-48	173WRTE	18				
163L-48-FA	12	(U) 830-48FB (V) ST2650FC	173WRTE	18				
163S-17	12	(V) SST1600C	173WRTE	18				
163S-17-CV	12	(U) 830-17	173WRTE	18				
163S-17-FA	12	(U) 830-17FB (V) SST2600FC	173WRTE	18				
163SL-21	12	(V) ST1602C	173WRTE	18				
163SL-21-CV	12	(U) 832-21	173WRTE	18				
163SL-21-FA	12	(U) 832-21FB (V) ST2602FC (V) ST1612C	173WRTE	18				
163SL-27	12		173WRTE	18				
163SL-27-CV	12		173WRTE	18				
163SL-27-FA	12		173WRTE	18				
163SL-36	12	(V) ST1632C	173WRTE	18				
163SL-36-CV	12	(U) 832-36	173WRTE	18				
163SL-36-FA	12	(U) 832-36FB (V) ST2632FC	173WRTE	18				
163SL-48	12	(V) ST1652C	173WRTE	18				
163SL-48-CV	12	(U) 832-48	173WRTE	18				
163SL-48-FA	12	(U) 832-48FB (V) ST2652FC	173WRTE	18				
171H	20	(U) TYPE28 (V) MFA-J	173WRTE	18				

CONCOA® & AIRCO® are registered trademarks of Controls Corps. of America.; FIREPOWER®, VICTOR® & CUTSKILL® are registered trademarks of Victor Equipment Company; HARRIS® is a registered trademark of The Lincoln Electric Company; PUROX® & ESAB® are registered trademarks of ESAB® Welding & Cutting Products; SMITH EQUIPMENT® is a registered trademark of Illinois Tool Works Inc.; UNIWELD® is a registered trademark of Uniweld Products Inc.; Western Enterprises® is a registered trademark of Scott & Fetzer Company. The above listed companies are not associated with Genstar Technologies Co., Inc.

EQUIVALENT CODE KEY (C) CONCOA/AIRCO®; (CS) CUTSKILL®; (FP) FIREPOWER®; (H) HARRIS®; (K) Koike; (P) PUROX/ESAB® (S) Superior; (SM) Smith Equipment®; (U) UNIWELD®; (V) VICTOR® ; (W) Western Enterprise®									
Model Number	PP	Equivalent Number	Model Number	PP	Equivalent Number	Model Number	PP	Equivalent Number	
190Y-15-3	34	(H) 301-15-300	195FM	65	(H) 55-2AR/CD70-1/4	230	70	(W) RPB-6	
		(SM) H1942E-300			(SM) H1108E			230A	70
		(U) MR8211-1			(U) UAF-1413			230G	70
190Y-15-5	34	(V) SR6-15-300	195FM-5	65	(W) RWS-2-13	230GA	70	(V) BF-50	
		(W) REB-1A-1			(H) 55-2AR/CD70(M)			230H	71
		(H) 301-15-520B			(V) FM147			230HA	71
191AR-60	63	(SM) H1941E-520	195FM-7	65	(H) 55-2AR/CD70	230HB	70	(W) RPB-6H	
		(U) MR8211-2			(V) FM137			230HBA	70
		(V) SR6-15-520			(SM) H1952D-580			230HBG	70
191AR-60-6HCS	66	(CS)HRF1425-580	195HE-150	64	(U) CEF14-8	230HBGA	70	(W) BR2H	
		(FP)HRF1480-580-FB			(U) HSR2537-580			230HBG	70
		(H) 355-2-AR-580			(W) RFS-5-P			230HBGA	70
191AR-60-6HCS	66	(U) FR1413	195STAR-60	64	(SM) H1760-580	230HGMYA	80	(V) BFH-50	
		(V) HRF2425-580			(V) HVTS2570-580			24-0007	80
		(W) REF-3-PG			(SM) H1765-320			24-0008	80
191CD-60	63	(CS) 0781-2743	195TCD-60	64	(V) HVTS2570-320	24-0009	80	(W) RPB-6HG	
		(FP) HRF1480-580FPH			(V) HVTS2570-580			24-0010	80
		(H) 355-2AR-58010			(H) 356-AR/HE-580			24-0011	80
191CD-60-6HCS	66	(W) REF-3-PGD	196AR-60	65	(SM) H1970-580(80SCFH)	24-0012	80	(W) BR2HG	
		(FP) HRF1480-580FPH			(U) DEF14			24-0013	80
		(U) KFR1413			(V) DFM150-580			24-0014	80
191CD-60	63	(W) REF-3-PGD	196HE-150	65	(W) RFD-3-P	24-0015	77	(W) BR72HG	
		(CS) HRF1480-320			(H) 356-AR/HE-580			24-0016	80
		(FP) HRF1480-320-FB			(U) DEF14			24-0017	80
191CD-60-6HCS	66	(H) 355-2-CD-320	198CD-60	67	(W) RFD-3-P	24-0018	80	(S) N20	
		(U) FR1413			199CD-60			67	80
		(V) HRF2480-320			(H) 4-CD100F-320			24-0019	80
191CD-60-6HCS	66	(W) REF-4-PG	20-1610-5	81	(V) SR311-320	24-0020	80	(S) N21	
		(CS) 0781-2745			20-1675-5			81	80
		(H) 355-2CD-32010			20-1710-5			81	80
191HE-150	63	(W) REF-4-PGD	20-1775-5	81		24-0030	80	(W) 7	
		(U) KFR13			210F-80			35	80
		(W) REF-4-PGD			210X-80			35	80
191NR-70	63	(H) 355-2-HE-320	210Y-15-3	35	(CS) SR5-60-540R	24-0031	80	(S) N10	
		(U) FR14-6			(FP) FPR-150CR-540			24-0032	80
		(V) HRF2425-580			(U) ROB			24-0033	80
191NR-70	63	(W) RF-3-P	210Y-15-3-A	35	(V) SR150CR-540	24-0034	80	(W) 9	
					(U) RCA			24-0035	80
					(U) RCA			24-0036	80
191QR-70	63		210Y-15-5	35	(U) RO	24-0037	80	(S) N11	
					(U) RWB			24-0038	80
					(U) RW			24-0039	80
194CE-100-110	69		210Y-15-510	35	(U) RMC	24-0040	77	(W) 10	
					(U) RMC2			24-0041	77
					(CS) SR6-15-200R			24-0042	77
194CE-100-220	69		210Y-15-A	35	(FP) FPR-160AR-200	24-0043	77	(S) A830	
					(U) RMC2B			24-0044	77
					(V) SR160AR-200			24-0045	77
194CE-100-36	69		210Y-15-510-A	35	(U) RMC2B	24-0046	77	(W) 15	
					(U) RCAB			24-0047	77
					(U) RCA			24-0048	77
194CE-60-110	69		220-50	62	(V) SR150CR-540	24-0049	80	(S) A800	
					(U) RWB			24-0050	80
					(U) RW			24-0051	80
194CE-60-220	69		227C	62	(U) RMC	24-0052	77	(W) 16	
					(U) RMC2			24-0053	77
					(CS) SR6-15-200R			24-0054	77
194CE-60-36	69		227CG	62	(FP) FPR-160AR-200	24-0055	77	(S) NP10	
					(U) RMC2B			24-0056	77
					(V) SR160AR-200			24-0057	77
195AE-60	68		227N	62	(U) RMC2B	24-0058	77	(W) 17	
					(U) RCAB			24-0059	77
					(U) RCA			24-0060	77
195AR-60	64	(SM) H1952D-580	229	70	(V) SR150CR-540	24-0061	80	(S) NP6	
		(U) CEF1413			(W) RP305810			24-0062	78
		(V) HSR2570-580			(W) RP320 SERIES			24-0063	78
195AR-60	64	(W) RFS-3-P	229-50-B	62	(U) RWB	24-0064	80	(W) 18	
					(U) RW			24-0065	80
					(U) RMC2			24-0066	80
195AR-60-680	64		229-50-P	62	(U) RMC	24-0067	77	(S) NP4	
					(FP) 0387-1232			24-0068	77
					(W) RP305810			24-0069	77
195AR-60-6HSP	66	(U) KF1413	229G	70	(CS) SR6-15-200R	24-0070	80	(W) 19	
		(SM) H1956D-320			(FP) FPR-160AR-200			24-0071	77
		(U) CEF1413			(U) RMC2B			24-0072	77
195CD-60	64	(V) HSR2570-320	229G	70	(V) SR160AR-200	24-0073	78	(S) C50	
		(W) RFS-4-P			(U) RCAB			24-0074	78
		(U) KF1413			(U) RCA			24-0075	78
195CD-60-6HSP	66		229G	70	(U) RWB	24-0076	80	(W) 30	
					(U) RW			24-0077	80
					(U) RMC2			24-0078	80
195FE	69		229G	70	(W) R125	24-0079	80	(S) C51	
					(W) R125G			24-0080	80
								24-0081	80

CONCOA® & AIRCO® are registered trademarks of Controls Corps. of America.; FIREPOWER®, VICTOR® & CUTSKILL® are registered trademarks of Victor Equipment Company; HARRIS® is a registered trademark of The Lincoln Electric Company; PUROX® & ESAB® are registered trademarks of ESAB® Welding & Cutting Products; SMITH EQUIPMENT® is a registered trademark of Illinois Tool Works Inc.; UNIWELD® is a registered trademark of Uniweld Products Inc.; Western Enterprises® is a registered trademark of Scott & Fetzer Company, The above listed companies are not associated with Genstar Technologies Co., Inc.

EQUIVALENT CODE KEY (C) CONCOA/AIRCO®; (CS) CUTSKILL®; (FP) FIREPOWER®; (H) HARRIS®; (K) Koike; (P) PUROX/ESAB® (S) Superior; (SM) Smith Equipment®; (U) UNIWELD®; (V) VICTOR® ; (W) Western Enterprise®								
Model Number	PP	Equivalent Number	Model Number	PP	Equivalent Number	Model Number	PP	Equivalent Number
24-0203	78	(S) V52 (W) 203	24-CV5TF	15	(U) TCV11 (W) CV-A10	4121	5	(H) Steelworker
24-0205	78	(S) V88 (W) 205	24-CV5TO	15	(U) TCV10 (W) CV-A9	4121-3	5	(H) Steelworker
24-0206	78	(S) V89 (W) 206	24-CV7PR	15	(H) 88-6CVT (U) TCVB (V) 0690-0011 (W) WE-60	4121FA	5	
24-0215-AR	78	(S) V454 (W) 215-AR				4121FA-3	5	
24-0306	77	(S) A842 (W) 306	24-CV7TF	15	(H) 88-6CVTL (U) TCV-101 (V) CTF (W) CV-8L	4131	5	(H) Pipeliner
24-0314	77	(S) A784 (W) 314				4131-3	5	(H) Pipeliner
24-0315	77	(S) A840 (W) 315	24-CV7TO	15	(H) 88-6CVTR (U) TCV-100 (V) CTO (W) CV-7R	4131FA	5	
24-0317	77	(S) A848 (W) 317				4131FA-3	5	
24-0318	77	(S) A850 (W) 318	24-CV8PR	15	(W) WE-62	442C	11	(H) 72-3 (U) CA79A (H) 85 (U) WH79-2
24-0319	77	(S) A844 (W) 319	24-CV8RF	15	(H) 88-7CVRL (W) CV-33L	442T	9	
24-0321	77	(S) A780 (W) 321	24-CV8RO	15	(H) 88-7CVRR (W) CV-32R	442T-CV	9	
24-0411	78	(S) YV420 (W) 411	24-CV9PR	15	(H) 88-6CVR (V) 0690-0012 (W) WE-61	442T-FA	9	
24-0415	77	(S) A876 (W) 415	24-CV9RF	15	(H) 88-6CVRL (U) RCV-101 (V) CRF (W) CV-31L	443C	11	(H) 73-3 (U) CA43A (H) 43-2 (U) 43L9
24-0662P	76	(S) HTN71P (W) 662P				443T	9	
24-0692P	76	(S) HTN73P (W) 692P	24-CV9RO	15	(H) 88-6CVRR (U) RCV-100 (V) CRO (W) CV-30R	443T-CV	9	
24-0769	80	(W,S) 769				443T-FA	9	
24-0806	77	(S) A809 (W) 806	24-CV9WB	31	(S) C2540 (W) T-62	452C-175	37	(U) RUH8213 (W) RS-4-4
24-0810	77	(S) A870 (W) 810	24-T-62	78	(S) C2580 (W) T-92	452C-175-F	37	
24-1690	77	(S) A802 (W) 1690	24-T-92	78		452C-300	37	
24-3588	80	(W,S) 3588	25-120	81		452C-300-F	37	
24-4750	80	(W,S) 4750	25-121	81		452F-125	37	
24-7322	80	(W,S) 7322	25-122	81		452F-40	37	(H) 25-50C-510P (U) RUH8212 (W) RS-10-2 (H) 25-200C-580 (U) RUH8215 (W) RS-7-4 (U) RUH8215A-1
24-7323	80	(W,S) 7323	25-130	81		452IN-175	37	
24-7325	80	(W,S) 7325	25-300	81		452IN-175-F	37	
24-7326	80	(W,S) 7326	25-450	81		452IN-175-F-680	37	
24-7327	80	(W,S) 7327	263L-21	13		452IN-175-WO	73	
24-7328	80	(W,S) 7328	263L-21-CV	13		452IN-300	37	(H) 25-200C-580
24-7329	80	(W,S) 7329	263L-21-FA	13		452IN-300-F	37	
24-9116	80	(W,S) 9116	263S-18	13		452IN-450	37	(H) 25-500C-580 (SM) H1935D-580 (W) RS-7-5
24-9940P	80	(W,S) 9940-P	263S-18-CV	13		452IN-450-F	37	
24-AW-14A	78	(S) N2400 (W) AW-14A	263S-18-FA	13		452IN-450-F-680	37	
24-AW-15A	78	(S) A404 (W) AW-15A	27-0005	81		452IN-80	37	(H) 25-100C-580 (W) RS-7-3 (H) 25-200C-540 (U) RUH8210 (W) RS-9-4
24-AW-17	78	(S) NP73 (W) AW-17	27-1013	81		452X-175	37	(H) 25-100C-540 (W) RS-9-3
24-AW430	78	(S) C126 (W) AW430	27-1013L	81		452Y-15	37	(H) 25-15C-510 (U) RUH8211 (W) RS-1-1
24-AW431	78	(S) C127 (W) AW431	342T-F	9		452Y-15-3	37	(H) 25-15C-300 (U) RUH8211-1 (W) RS-1A-1
24-CV5PR	15	(U) TCVA (W) WE-63	342T-F-CV	9		452Y-15-5	37	(H) 25-15C-520 (U) RUH8211-2 (H) 425-200-540
			342T-F-FA	9		453X-175	38	
			342T-Y	9		453X-175G	38	
			342T-Y-CV	9			75	
			342T-Y-FA	9			75	
			363S-18	13				
			363S-18-CV	13				
			363S-18-FA	13				

CONCOA® & AIRCO® are registered trademarks of Controls Corps. of America.; FIREPOWER®, VICTOR® & CUTSKILL® are registered trademarks of Victor Equipment Company; HARRIS® is a registered trademark of The Lincoln Electric Company; PUROX® & ESAB® are registered trademarks of ESAB® Welding & Cutting Products; SMITH EQUIPMENT® is a registered trademark of Illinois Tool Works Inc.; UNIWELD® is a registered trademark of Uniweld Products Inc.; Western Enterprises® is a registered trademark of Scott & Fetzer Company, The above listed companies are not associated with Genstar Technologies Co., Inc.

EQUIVALENT CODE KEY (C) CONCOA/AIRCO®; (CS) CUTSKILL®; (FP) FIREPOWER®; (H) HARRIS®; (K) Koike; (P) PUROX/ESAB® (S) Superior; (SM) Smith Equipment®; (U) UNIWELD®; (V) VICTOR® ; (W) Western Enterprise®								
Model Number	PP	Equivalent Number	Model Number	PP	Equivalent Number	Model Number	PP	Equivalent Number
453Y-15	38	(H) 425-15-510	463SEL-21	13		591IN-4500-680	33	(H) 8700-4500-680
	75		463SEL-21-CV	13	(U) 40B-21			(V) SR4K-680
453Y-15-3	38	(H) 425-15-300	463SEL-21-FA	13		591IN-750	33	(SM) HB1882-580
	75		463SEL-36	13				(600psi)
453Y-15-3G	38		463SEL-36-CV	13	(U) 40B-36			(V) SR4F-580
	75		463SEL-36-FA	13		591Q-1500	33	(H) 8700-1500-346
453Y-15G	38		463SF-18	13				(V) SR4G-346
	75		463SF-18-CV	13	(H) 62-5BF	591Q-1500-347	33	(H) 8700-1500-347
462TF-40	48				(U) 40BF-18			(V) SR4G-347
463AE-18	13		463SF-18-FA	13		591Q-3000	33	(V) SR4J-346
463AE-18-CV	13	(H) 62-5AE	463SFL-21	13		591Q-3000-347	33	(H) 8700-3000-347
		(U) 40-18	463SFL-21-CV	13	(H) 62-5BFL 21			(V) SR4J-347
463AE-18-FA	13				(U) 40BF-21	591Q-4500-347	33	(H) 8700-4500-347
463AEL-21	13		463SFL-21-FA	13				(V) SR4K-347
463AEL-21-CV	13	(H) 62-5AEL 21	463SFL-36	13		591X-1500	33	(H) 8700-1500-540
		(U) 40-21	463SFL-36-CV	13	(H) 62-5BFL 36			(V) SR4G-540
463AEL-21-FA	13				(U) 40BF-36			(W) RS-9-15
463AEL-36	13		472C	23	(H) 6290	591X-3000	33	(V) SR4J-540
463AEL-36-CV	13	(H) 62-5AEL 36			(U) 6290A			(W) RS-9-20 (2000psi)
		(U) 40-36	472CN	23	(H) 6290NX	591X-750	33	(V) SR4F-540
463AEL-36-FA	13				(U) 6290NX	63L-4	7	(U) KR830-21
463AF-18	13		472H-2	21	(H) J-63-2	63L-4FA	7	(U) KR830-21FB
463AF-18-CV	13	(H) 62-5AF			(U) 7928E			(V) Cutter Select
		(U) 40F-18	472M	17	(H) D-85	63L-5	7	(U) KV830-21
463AF-18-FA	13				(U) UM79	63L-5FA	7	(U) KV830-21FB
463AFL-21	13		472M	21				(V) Cutter Select
463AFL-21-CV	13	(H) 62-5AFL 21				672C	23	(C) 144
		(U) 40F-21	472W	17	(H) 23A90			(U) 144
463AFL-21-FA	13				(U) Type 79E	672CHN	23	(K) 107D7
463AFL-36	13		473CHN	23	(H) 6290VVC	673C	23	(C) 164
463AFL-36-CV	13	(H) 62-5AFL 36			(U) 6290VVC			(U) 164
		(U) 40F-36	473M	17	(H) E-43	673CHNP	23	(K) 106D7
463AFL-36-FA	13				(H) UM43	710F-80	26	(SM) H1945E-510
463E-18	13							
463E-18-CV	13	(H) 62-5E	572C	23	(FP) MC12	710X-80	26	(SM) H1940G-540
		(U) 40A-18			(SM) MC12			
463E-18-FA	13		572CN	23	(FP) MC40	710X-80-A	26	
463EL-21	13				(SM) MC40	710X-80G	29	
463EL-21-CV	13	(H) 62-5EL 21	573C	23	(FP) SC12	710Y-15	26	(SM) H1944F-200
		(U) 40A-21			(SM) SC12			
463EL-21-FA	13		591H-1500	33	(H) 8700-1500-350	710Y-15-5	26	(SM) H1941E-520
463EL-36	13				(V) SR4G-350			
463EL-36-CV	13	(H) 62-5EL 36	591H-3000	33	(V) SR4J-350	710Y-15G	29	
		(U) 40A-36	591H-750	33	(V) SR4F-350	752X-80	75	
463EL-36-FA	13		591IN-1500	33	(H) 8700-1500-580	752X-80G	75	
463F-18	13				(SM) HB1883-580	752Y-15	75	
463F-18-CV	13	(H) 62-5F			(1000psi)	752Y-15G	75	
		(U) 40AF-18			(V) SR4G-580	753X-125	75	
463F-18-FA	13				(W) RS-11-15	753X-125G	75	
463FL-21	13		591IN-1500-680	33	(H) 8700-1500-680	753Y-15	75	
463FL-21-CV	13	(H) 62-5FL 21			(SM) HB1893-680	753Y-15G	75	
		(U) 40AF-21			(1000psi)	772C	23	(P) 4202
463FL-21-FA	13				(V) SR4G-680			(U) 4202
463FL-36	13		591IN-3000	33	(SM) H803-580	791AR-60	63	(SM) H2051-580
463FL-36-CV	13	(H) 62-5FL 36			(2500psi)	791AR-60-6HSP	66	(SM) H2051-580-H
		(U) 40AF-36			(V) SR4J-580	853F-80	39	(CS) RC350-40-510LP
463FL-36-FA	13				(W) RS-11-20			(V) SR361B-510
463SE-18	13				(2000psi)	853LCRCD-125	40	(H) 330-125-320
463SE-18-CV	13	(U) 40B-18	591IN-3000-680	33	(H) 8700-3000-680			(V) LC350DR-320
					(V) SR4J-680	853LCRIN-125	40	(H) 330-125-580
463SE-18-FA	13							(V) LC350DR-580

CONCOA® & AIRCO® are registered trademarks of Controls Corps. of America.; FIREPOWER®, VICTOR® & CUTSKILL® are registered trademarks of Victor Equipment Company; HARRIS® is a registered trademark of The Lincoln Electric Company; PUROX® & ESAB® are registered trademarks of ESAB® Welding & Cutting Products; SMITH EQUIPMENT® is a registered trademark of Illinois Tool Works Inc.; UNIWELD® is a registered trademark of Uniweld Products Inc.; Western Enterprises® is a registered trademark of Scott & Fetzer Company. The above listed companies are not associated with Genstar Technologies Co., Inc.

INDEX & COMPARISON CHART

Welding & Cutting Apparatus Chart

Industrial Gas Apparatus

EQUIVALENT CODE KEY (C) CONCOA/AIRCO®; (CS) CUTSKILL®; (FP) FIREPOWER®; (H) HARRIS®; (K) Koike; (P) PUROX/ESAB® (S) Superior; (SM) Smith Equipment®; (U) UNIWELD®; (V) VICTOR® ; (W) Western Enterprise®								
Model Number	PP	Equivalent Number	Model Number	PP	Equivalent Number	Model Number	PP	Equivalent Number
853LCRX-125	40	(H) 330-125-540 (V) LC350DR-540	875HEL	21	(U) Type VHE (V) Type 55 Elbow	FA7RPR	16	(CS) FBR-2 (H) 88-5FBR
853LF-125	54	(V) L361D-250 (W) WMR-3-3	875HRB	21	(U) Type VH (V) Type 55 Head			(U) RFAB (V) FBR-1
853LX-125	54	(V) L350D-250 (W) WMR-3-3	876M	21	(U) UM12-1 (V) Type 55 Mixer			(V) FPRA (W) FA-30
853LY-15	54	(V) L360A-250 (W) WMR-3-1	881W	18	(V) UN-J	FA7TF	16	(U) TFA101 (V) FB-F
853SF-80	50	(H) 547-50-CL (V) S361C-025	881W-TT	18				(W) FA-200-P
853SRF-80	51	(H) 447-50-CL (V) S361CR-025	882W	18	(V) UN-1	FA7TO	16	(U) TFA100 (V) FB-O
853SRIN-125	51	(H) 447-125-CRM (V) S350DR-034	883TEMFA	18	(V) TEMFA			(W) FA-100-P
853SRIN-80	51	(H) 447-50-CRM (V) S350CR-034	883TEMFN	18	(V) TEMFN	FA7TPR	16	(CS) FBT-2 (FP) FPTA
853SRX-125	51	(H) 447-125-CR (V) S350DR-024	883TEN	18	(V) TEN			(H) 88-5FBT (U) TFAB
853SRX-80	51	(H) 447-50-CR (V) S350CR-024	883W	18	(V) UN			(V) FB-1
853SRY-15	51	(V) S360AR-025 (W) WSR-1-5	9-WG1P	81		FA7TPR	16	(W) FA-10
853SX-125	50	(SM) H1775C (V) S350D-024	9-WG6G	81		G13-8VM	19	(U) TYPE 13 #8 VM
853SX-40	50	(V) S350B-024	C-1	79	(S) KT10 (W) C-1	G13-8VM	19	(V) DEF-J
853SX-80	50	(V) S350C-024	C-5	79	(S) KT28 (W) C-5	G15-030RL	74	(V) 1424-0147
853SY-15	51	(SM) H1779C (V) S360A-025	CK-0	79	(W) CK-0	G15-100	74	(V) 1424-0148
853X-125	39	(CS)RC350-125-540 (FP)350-125-540-FB (V) SR350D-540	CK-1SP	79	(S) RK6 (W) CK-1	G15-200	74	
853X-125G	39		CK-20SP	79	(S) RK5 (W) CK20	G15-3MEF	74	
853Y-15	39	(CS)RC350-15-510 (FP)350-15-510-FB (V) SR360A-510	CK-22SP	79	(W) CK-22	G15-400	74	(V) 1424-0149
853Y-15-3	39	(CS)RC350-15-300 (V) SR360A-300	CK-24SP	79	(S) RK24 (W) CK-24	G15-4000	74	(V) 1424-0150
853Y-15-3G	39		CK-26SP	79	(S) RK26 (W) CK26	G17	18	(V) UN-J+TEN
853Y-15G	39		CK-5SP	79	(S) RK27 (W) CK-5	G17-FT	19	(U) TYPE 17 #9 (V) EF-J
871H	20		CRT10	6		G17-VMA-1	19	(U) TYPE 17 #30
871M	17	(U) UM17	CRT20N	73		G20-030RL	74	(V) 1424-0257
871W	17	(U) Type 17E	CRT40N	73		G20-050CF	74	(V) 1424-0002
872H	20		CY10-MC	6		G20-060	74	
872M	17	(U) UM13	CY20-540	6		G20-100	74	(V) 1424-0259
872W	17	(U) Type 13E (V) ET, ET1	CY20-580	73		G20-1500	74	
873H	20		CY40-580	73		G20-200	74	
873M	17	(U) UM4	FA10RF	16	(H) 88-5FBHFRL	G20-300	74	
873W	17	(U) Type 4E (V) ET	FA10RO	16	(H) 88-5FBHFRR	G20-3000	74	
			FA20PF	16		G20-400	74	(V) 1424-0261
			FA20PO	16		G20-4000	74	(V) 1424-0284
			FA23RF	16		G20-600	74	
			FA23RO	16		G20-6000	74	
			FA5RF	16	(U) RFAM101	G20B-030RL	74	(V) 1424-0013
			FA5RO	16	(U) RFAM100	G20B-100	74	(V) 1424-0015
			FA5RPR	16	(U) RFAA	G20B-200	74	(V) 1424-0016
			FA5TF	16	(U) TFAM101	G20B-3000	74	
			FA5TO	16	(U) TFAM100	G20B-400	74	(V) 1424-0017
			FA5TPR	16	(U) TFAA	G20B-4000	74	(V) 1424-0019
			FA7RF	16	(U) RFA101 (V) FB-FR (W) FA-230-P	G20B-600	74	
			FA7RO	16	(U) RFA100 (V) FB-OR (W) FA-130-P	G20B-F030R	74	
						G20B-F100	74	
						G20B-F200	74	
						G20B-F400	74	
						G20B-F4000	74	
						G25B-030RL	74	(V) 1424-0035
						G25B-100	74	(V) 1424-0036
						G25B-200	74	(V) 1424-0039
						G25B-3000	74	
						G25B-400	74	(V) 1424-0046

CONCOA® & AIRCO® are registered trademarks of Controls Corps. of America.; FIREPOWER®, VICTOR® & CUTSKILL® are registered trademarks of Victor Equipment Company; HARRIS® is a registered trademark of The Lincoln Electric Company; PUROX® & ESAB® are registered trademarks of ESAB® Welding & Cutting Products; SMITH EQUIPMENT® is a registered trademark of Illinois Tool Works Inc.; UNIWELD® is a registered trademark of Uniweld Products Inc.; Western Enterprises® is a registered trademark of Scott & Fetzer Company, The above listed companies are not associated with Genstar Technologies Co., Inc.

EQUIVALENT CODE KEY (C) CONCOA/AIRCO®; (CS) CUTSKILL®; (FP) FIREPOWER®; (H) HARRIS®; (K) Koike; (P) PUROX/ESAB® (S) Superior; (SM) Smith Equipment®; (U) UNIWELD®; (V) VICTOR® ; (W) Western Enterprise®								
Model Number	PP	Equivalent Number	Model Number	PP	Equivalent Number	Model Number	PP	Equivalent Number
G25B-4000	74	(V) 1424-0037	KSTA06-H12SP	25	(SM) 23-1020			(W) QDB205
G25B-60	74	(V) 1424-0034			(U) ART1020	QC-HHF-M-A	15	
G25B-600	74		KSTA06SP	25	(SM) 23-1012	QC-HHPR	15	(K) WZA
G25B-6000	74				(U) ART1012			(W) QDB20
G25B-F030R	74		KSTA16B-H12SP	25		QC-HHPR-A	15	
G25B-F100	74		KSTA16-BSP	25	(SM) 23-1003B	QC-HHX	15	(K) ZASP-1
G25B-F200	74				(U) ART1003B			(W) QDB22
G25B-F400	74		KSTA16-H12SP	25		QC-HHX-A	15	
G25B-F4000	74		KSTA16SP	25	(SM) 23-1003	QC-HHX-F	15	(K) AS-1
G25B-F600	74				(U) ART1003			(W) QDB101
GKNT	73		KSTA16TC-H12SP	25		QC-HHX-F-A	15	
GKNT20-T	73		KSTA16-TCSP	25	(SM) 23-1004A	QC-HHX-M	15	(K) ZAP-1
GKNT20-TC	73				(U) ART1004A			(W) QDB105
GKNT40-T	73		KSTP06-H12SP	25	(SM) 23-1020LP	QC-HHX-M-A	15	
GKNT40-TC	73				(U) ART1020LP	QC-HTF	15	(K) ZOSP-2
GMTR	19	(U) MTR	KSTP14-540SP	25	(U) ART1014			(V) KCF
GMTT	19	(U) MTT	KSTP14-TSP	25	(SM) 23-1014			(W) QDB11
GMTW-1	19	(U) MTW #1	KSTP16-H12SP	25		QC-HTF-F	15	(K) AS-2
GMTW-2	19	(U) MTW#2	KSTP16SP	25	(SM) 23-1003P			(W) QDB201
GP20X	75	(V) 1429-0068			(U) ART1003P	QC-HTF-M	15	(K) ZOP-2
GP20Y	75	(V) 1429-0069	KSTP16TC-H12SP	25				(W) QDB200
GP21X	75	(V) 1429-0068	MC105A	14	(U) 67-6TV	QC-HTPR	15	(FP) FPKC
GP21Y	75	(V) 1429-0069	MC105AR	14	(U) 67-6TV			(H) 26-QCT
GP31X	75	(V) 1429-0056			(V) MT5			(K) WZO
GP31Y	75	(V) 1429-0057	MC105F	14	(U) 67F-6TV			(V) KC-1
GP32X	75	(V) 1429-0066	MC105FR	14	(U) 67F-6TV			(W) QDB10
GP32Y	75	(V) 1429-0067			(V) MTN5	QC-HTX	15	(K) ZOSP-1
GR15-3MEF	72	(W) WG-18-4000W	MC205A	14	(U) 67-6			(V) KCO
GR15-4000	74	(V) 1424-0001			(V) MT204A			(W) QDB12
GR15-4000G	74		MC205AR	14		QC-HTX-F	15	(K) AS-1
GR20B-F100	74		MC205F	14	(U) 67F-6			(W) QDB101
GR20B-F200	74		MC205FR			QC-HTX-M	15	(K) ZOP-1
GR20B-F400	74		MC210A	14	(U) 67			(W) QDB100
GR20B-F600	74		MC210AR	14	(U) 67-R	QC-RHF	15	(K) ZGSP-2
GRST-LP	26	(SM) 249-500			(V) MT210A			(W) QDB31
		(U) RP3B	MC210F	14	(U) 67F	QC-RHF-A	15	
GRST-X	26	(SM) 249-499	MC210FR	14	(U) 67F-R	QC-RHF-F	15	(K) GS-2
		(U) RPO3B			(V) MT210N			(W) QDB206
GX15	74	(V) 1429-0029	MC310A	14	(U) 67-T	QC-RHF-F-A	15	
GX20	74	(V) 1429-0027	MC310AR	14	(U) 67-TR	QC-RHF-M	15	(K) ZAP-2
GX25	74	(V) 1429-0028			(V) MT310A			(W) QDB205
HQ14-012	73		MC310F	14	(U) 67F-T	QC-RHF-M-A	15	
HST18-06	26	(SM) 13254-4-6	MC310FR	14	(U) 67F-TR	QC-RHPR	15	(H) 26-QCR
		(U) ARTH6B			(V) MT310N			(K) WZG
HST18-12	26	(SM) 13254-4-12	MC318A	14	(U) 67-TL			(W) QDB30
	29	(U) ARTH12B	MC318AR	14	(U) 67-TRL	QC-RHPR-A	15	
					(V) MT318A	QC-RHX	15	(K) ZGSP-1
HW23-012	81		MC318F	14	(U) 67F-TL			(W) QDB32
HW23-T015	81		MC318FR	14	(U) 67F-TRL	QC-RHX-A	15	
HW23-T020	81				(V) MT318N	QC-RHX-F	15	(K) GS-1
HW24-050	81		MC-BCHA	14	(V) BHA 2			(W) QDB106
HW24-T020	81		MC-HT-BCHA	14	(V) 0304-0060	QC-RHX-F-A	15	
HW24-T025	81					QC-RHX-M	15	(K) ZAP-1
HWB-10CV	31	(FP) VF-10-RH	MT100-16	14				(W) QDB105
KCMA04SP	28		MT200-16	14				
KCMA16-BSP	28		MT300-16	14				
KCMA16SP	28		QC-HHF	15	(K) ZASP-2	R110-56	76	(S) F6
KCMA16TCSP	28				(W) QDB21			(W) S-3
KCMA26SP	28		QC-HHF-A	15		R120-56	76	
KCMP16SP	28		QC-HHF-F	15	(K) AS-2	R195-03	78	
KSTA04SP	25	(SM) 23-1007A	QC-HHF-F-A	15	(W) QDB201	R230-03	78	
		(U) ART1007A	QC-HHF-M	15	(K) ZAP-2	R231-12	78	(S) A115
						R231-12	78	(W) 543

CONCOA® & AIRCO® are registered trademarks of Controls Corps. of America.; FIREPOWER®, VICTOR® & CUTSKILL® are registered trademarks of Victor Equipment Company; HARRIS® is a registered trademark of The Lincoln Electric Company; PUROX® & ESAB® are registered trademarks of ESAB® Welding & Cutting Products; SMITH EQUIPMENT® is a registered trademark of Illinois Tool Works Inc.; UNIWELD® is a registered trademark of Uniweld Products Inc.; Western Enterprises® is a registered trademark of Scott & Fetzer Company. The above listed companies are not associated with Genstar Technologies Co., Inc.

INDEX & COMPARISON CHART

Welding & Cutting Apparatus Chart

Industrial Gas Apparatus

EQUIVALENT CODE KEY (C) CONCOA/AIRCO®; (CS) CUTSKILL®; (FP) FIREPOWER®; (H) HARRIS®; (K) Koike; (P) PUROX/ESAB® (S) Superior; (SM) Smith Equipment®; (U) UNIWELD®; (V) VICTOR® ; (W) Western Enterprise®								
Model Number	PP	Equivalent Number	Model Number	PP	Equivalent Number	Model Number	PP	Equivalent Number
RB205-1BT	72	(W) RPB-5-1BT	RNPCO5	76	(S) W6	ROB134	78	(S) B26
RB205-1F	72	(W) RPB-5-1F			(W) CO-5		78	(W) 134
RB205-1FV	72	(W) RPB-5-1FV	RNPCO6N	76	(S) W8	ROB135	78	(S) B27
RB205-1L	72	(W) RPB-5-1L			(W) CO-6N			(W) 135
RB205-1N	72	(W) RPB-5-1N	RNPOR-11	76	(S) OR580	ROB316	78	(S) A112
RB205-1P	72	(W) RPB-5-1P			(W) 615-0			(W) 540
RB205-1V	72	(W) RPB-5-1V	RNT14-2	76	(W) 14-2	ROB32	78	(S) B28
RB205-1X	72	(W) RPB-5-1X	RNT15-2	76	(S) N69			(W) 32
RB205-2V	72	(W) RPB-5-2V			(W) 15-2	ROB33	78	(S) B29
RB232	72		RNT16-2	76	(S) N56			(W) 33
RB234	72				(W) 16-2	ROB34	78	
RB236	72	(W) TH1	RNT300-2	76	(S) N70	ROB48F	78	(S) FA1652
RB237	72	(W) BRC			(W) 300-2	ROB532	78	
RNP14-3	76	(S) NP753	RNT305-2	76	(S) N57	RP-2HP	72	(W) P-2HP
		(W) 14-3			(W) 305-2	RP-4HP	72	(W) P-4HP
RNP14-3SF	76	(S) NP753R	RNT347-2	76	(W) 347-2	T10-82B	29	
		(W) 14-3SF	RNT62	76	(S) N71	T10-83B	29	
RNP15-23SF	76				(W) 62	T110-26	30	
RNP15-3	76	(S) NP189	RNT680-2	76	(S) N680	T110-27	30	
		(W) 15-3			(W) 680-2	TF7000	73	
RNP15-3SF	76	(S) NP189R	RNT82	76	(W) 82	TW146	73	
		(W) 15-3SF	RNT92	76	(S) N73	WB-500T	31	(FP) RHT-500
RNP16-8	76	(S) NP128			(W) 92	WBK-500	31	(FP) HT-500FP
		(W) 16-8	RNT92-HT	76	(S) N73P			(U) WB500
RNP16-8SF	76	(S) NP128R			(W) 692			
		(W) 16-8SF	RNT93	76	(S) N74			
RNP300-3	76	(S) NP435	RNTCO2	76	(W) 93			
		(W) 300-3			(S) N61			
RNP300-3SF	76	(S) NP435R	ROB134	78	(S) B26			
		(W) 300-3SF			(W) 134			
RNP305-3A	76	(S) NP414	RNPCO5	76	(S) W6			
		(W) 305-3A			(W) CO-5			
RNP305-3ASF	76	(S) NP414R	RNPCO6N	76	(S) W8			
		(W) 305-3ASF			(W) CO-6N			
RNP347-3	76	(S) NP765	RNPOR-11	76	(S) OR580			
		(W) 347-3			(W) 615-0			
RNP347-3SF	76	(S) NP765R	RNT14-2	76	(W) 14-2			
		(W) 347-3SF	RNT15-2	76	(S) N69			
RNP615-25SF	76				(W) 15-2			
RNP615-3	76	(S) NP190W	RNT16-2	76	(S) N56			
		(W) 615-3			(W) 16-2			
RNP615-3SF	76	(S) NP190WR	RNT300-2	76	(S) N70			
		(W) 615-3SF			(W) 300-2			
RNP61-SF	76		RNT305-2	76	(S) N57			
RNP66	76	(S) NP211			(W) 305-2			
		(W) 66	RNT347-2	76	(W) 347-2			
RNP66-SF	76	(S) NP211R	RNT62	76	(S) N71			
		(W) 66-SF			(W) 62			
RNP680-3	76	(S) NP843	RNT680-2	76	(S) N680			
		(W) 680-3			(W) 680-2			
RNP680-3SF	76	(S) NP843R	RNT82	76	(W) 82			
		(W) 680-3SF	RNT92	76	(S) N73			
RNP83	76	(S) NP168			(W) 92			
		(W) 83	RNT92-HT	76	(S) N73P			
RNP83SF	76	(S) NP168R			(W) 692			
		(W) 83SF	RNT93	76	(S) N74			
RNPCO3	76	(S) NP147			(W) 93			
		(W) CO-3	RNTCO2	76	(S) N61			
RNPCO3-SF	76	(S) NP147R			(W) CO2			
		(W) CO-3SF						

CONCOA® & AIRCO® are registered trademarks of Controls Corps. of America.; FIREPOWER®, VICTOR® & CUTSKILL® are registered trademarks of Victor Equipment Company; HARRIS® is a registered trademark of The Lincoln Electric Company; PUROX® & ESAB® are registered trademarks of ESAB® Welding & Cutting Products; SMITH EQUIPMENT® is a registered trademark of Illinois Tool Works Inc.; UNIWELD® is a registered trademark of Uniweld Products Inc.; Western Enterprises® is a registered trademark of Scott & Fetzer Company, The above listed companies are not associated with Genstar Technologies Co., Inc.

Model Number	GENTEC Number	PP	Model Number	GENTEC Number	PP	Model Number	GENTEC Number	PP
VICTOR® to GENTEC®			(V) VTS461D-510	153TF-125	46			
(V) SST900C	162S-17	12	(V) VTS700D-540	155TX-125	47			
(V) SST900FC	162S-17-FA	12	(V) VTS700E-540	155TX-200	47			
(V) ST1600C	163L-21	12	(V) VTS700MD-996	155TMIN-125	59			
(V) ST1601C	163AL-21	12	(V) VTS700ME-996	155TMIN-200	59			
(V) ST1602C	163SL-21	12	(V) VTS710A-300	155TY-15-3	47			
(V) ST1610C	163L-27	12	(V) VTS710A-510	155TY-15	47			
(V) ST1611C	163AL-27	12	(V) VTS710D-580	155TIN-125	47			
(V) ST1612C	163SL-27	12	(V) VTS710E-580	155TIN-200	47			
(V) ST1630C	163L-36	12	(V) VTS710MA-997	155TMY-15	59			
(V) ST1631C	163AL-36	12	(V) VTS711D-510	155TF-125	47			
(V) ST1632C	163SL-36	12	(V) W	173W	17			
(V) ST1650C	163L-48	12	(V) W-1	172W	17			
(V) ST1651C	163AL-48	12	(V) W-J	171W	17			
(V) ST1652C	163SL-48	12						
(V) ST2600FC	163L-21-FA	12						
(V) ST2601FC	163AL-21-FA	12						
(V) ST2602FC	163SL-21-FA	12						
(V) ST2610FC	163L-27-FA	12						
(V) ST2611FC	163AL-27-FA	12						
(V) ST2630FC	163L-36-FA	12						
(V) ST2631FC	163AL-36-FA	12						
(V) ST2632FC	163SL-36-FA	12						
(V) ST2650FC	163L-48-FA	12						
(V) ST2651FC	163AL-48-FA	12						
(V) ST2652FC	163SL-48-FA	12						
(V) ST900C	162L-21	12						
(V) ST900FC	162L-21-FA	12						
(V) Super Range II	1221FA	3						
	1221FA-3	3						
(V) TE	883TE	18						
(V) TEMFA	883TEMFA	18						
(V) TEMFN	883TEMFN	18						
(V) TEN	883TEN	18						
(V) Type 55	175HN	21						
(V) Type 55 Elbow	875HEL	21						
(V) Type 55 Head	875HRB	21						
(V) Type 55 Mixer	876M	21						
(V) UM	873M	17						
(V) UM-1	872M	17						
(V) UM-J	871M	17						
(V) UN	883W	18						
(V) UN-1	882W	18						
(V) UN-1+TEN	172WRTE	18						
(V) UN-J	881W	18						
(V) UN-J+TEN	G17	18						
(V) VTS250C-540	152TX-80	45						
(V) VTS250D-346	152TQ-125	45						
(V) VTS250D-580	152TIN-125	45						
(V) VTS260A-300	152TY-15-3	45						
(V) VTS260A-510	152TY-15	45						
(V) VTS261B-510	152TF-80	45						
(V) VTS450D-540	153TX-125	46						
(V) VTS450D-580	153TIN-125	46						
(V) VTS450D-590	153TQ-125	46						
(V) VTS450E-346	153TQ-200	46						
(V) VTS450E-540	153TX-250	46						
(V) VTS450E-580	153TIN-250	46						
(V) VTS453D-320	153TC-125	46						
(V) VTS453E-320	153TC-200	46						
(V) VTS460A-300	153TY-15-3	46						
(V) VTS460A-510	153TY-15	46						

CATALOGS

GENTEC® Related Catalogs

Industrial Gas Apparatus

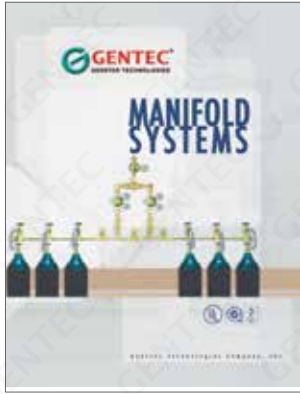

Manifold Systems



Ultra High Purity



Specialty Gas



HVAC



Medical Respiratory

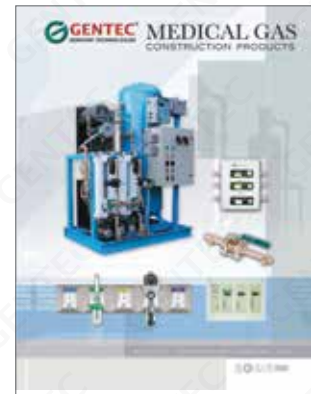

Medical Construction



Genstar Technologies Company, Inc.
4525 Edison Avenue, Chino, CA 91710, USA
Tel: 909-606-2726
Fax: 909-606-6485
www.gentec.com

